

Jafung_artikel-20

by Abraham Lomi

Submission date: 21-Apr-2023 11:16PM (UTC+0700)

Submission ID: 2071420393

File name: C.1.c.1-20_artikel_LOMI.pdf (2.31M)

Word count: 4479

Character count: 22825



Model design of an architectural grid-connected photovoltaic system

Abraham Lomi^{a*}, Meita Rumbayan^b, Yasuke Nakanishi^c, Kazuaki Iwamura^c, Noel Regis Estoperez^d,
Udom Lewlomphaisarl^e, Erkata Yandri^f, Muhammad Zahoor^g and Ivar Zekker^h

^a Department of Electrical Engineering, National Institute of Technology, Jl. Raya Karanglo, Km. 2, Malang 65143, Indonesia
^b Department of Electrical Engineering, Sam Rangi University, Kampus Bahu Unsrat, 95115 Manado, North Sulawesi, Indonesia
^c Graduate School of Energy and Environment, 3-4-1 Okubo, Shinjuku-ku, Tokyo 169-8555, Japan
^d Mindanao State University, Iligan Institute of Technology, Andronifacio Ave, Iligan City, 9200 Lanao del Norte, Philippines
^e National Advanced Automation and Electronics Research Unit, 112 Phahonyothin Road, Khlong Nueng, Khlong Luang District, Pathumthani 12120, Thailand
^f Graduate School of Renewable Energy, Darma Persada University, Jl. Radin Inten 2, Pondok Kelapa, East Jakarta 13450, Indonesia
^g Department of Biochemistry, University of Malakand, Lower Dir 18800, Pakistan
^h Institute of Chemistry, University of Tartu, Ravila 14a, 50411 Tartu, Estonia

Received 15 September 2021, accepted 12 January 2022, available online 15 November 2022

© 2022 Authors. This is an Open Access article distributed under the terms and conditions of the Creative Commons Attribution 4.0 International License CC BY 4.0 (<http://creativecommons.org/licenses/by/4.0>).

Abstract. Renewable energy sources such as solar, thermal and wind are high energy sources that meet the growing demand for electrical energy worldwide. Renewable energy sources can stand-alone power generators or multi-generations systems forming a microgrid system that can also be integrated into the main power grid. The integration of renewable energy sources into the main grid system mostly occurs at distribution levels and depends on the scale and location of the renewable energy sources. Renewable energy sources with large-scale capacity can be integrated into the transmission system, while small-scale energy sources can be integrated directly into medium- and low-voltage distribution systems. Both sources have their characteristics, therefore strict planning and analysis is needed. Architecture of a small-scale photovoltaic (PV) system is designed to generate about 3 kW for local demand, such as an office building, with the implementation of microgrid system equipped with smart meters for energy monitoring, and a control scheme is proposed.

Keywords: alternative energy, energy management, environmental sustainability, microgrid, renewable energy, small-scale PV system, smart system.

1. INTRODUCTION

The electricity crisis in Indonesia can be averted with comprehensive planning, management of energy systems (demand-side management), efforts to utilize alternative energy sources and energy conservation. Dependence on fossil energy sources should be reduced and on the other hand, the utilization of new and renewable energy sources should increase. In the long term, fossil energy use must decline given the petroleum depletion and environmental

unsustainability [1–3]. Indonesia is one of the countries that has committed to reducing greenhouse gas emissions (GHG) to 29% below the current level by 2030 or a 41% reduction target contingent on sufficient international financial support. Indonesia also submitted its first long-term strategy to the United Nations Framework on Climate Change Conference, UNFCCC, which indicates the country plans to peak GHG emissions in 2030 and reach net-zero GHG emissions by 2060 or sooner [4–6].

The demand for electrical energy in Indonesia continues to increase with the population growth and become an integral part of the needs of people living in line with

* Corresponding author, abraham@lecturer.itn.ac.id

the rapid advances in technology, industry, and information [23]. However, the implementation of electricity supply by PT. Perusahaan Listrik Negara (PLN – Persero, State Electricity Company) still cannot meet the energy needs of the consumer or load demand [4]. The geographical topology of the Republic of Indonesia consisting of thousands of islands has led to uneven distribution of power plants. The national energy development target, in general, has been set in Presidential Regulation No. 5 of 2006 with an indicator of the percentage of energy share in the primary energy mix and the energy elasticity to be achieved by 2025 [1,3].

Indonesia is a tropical country in the equator, so the potential for solar energy is high enough with an average shine of 6 to 7 hours per day with an ideal duration of irradiation that can be utilized to generate electrical energy through solar panels for 5 to 6 hours per day. It is a country rich in natural resources with a primary energy source that can be managed and used to meet national energy needs of electrical energy to remote communities [1,3,7].

Renewable energy sources with small capacity such as micro-hydro, solar thermal, biogas, biomass, and small wind turbine are already widespread. The size and capacity of the generation can vary from several hundred kilowatts to several megawatts. The small-scale renewable sources can be connected [4] the PLN grid on both medium and low voltage levels. The integration of small-scale renewable sources into the grid system is not necessarily done directly, but through an interface consisting of power electronic devices that convert the DC to DC or DC to AC or AC to DC [8–10]. This conversion process creates harmonic, energy conversion efficiency, and power quality issues due to using power electronics circuits. HVDC transmission, reactive power compensation with voltage source converter (VSC) technology has certain attributes which can be beneficial to overall system performance [11]. Also, other issues arise when integrating renewable energy generation into the network, such as harmonics, voltage dips, [4] overvoltage, and flicker voltages. Increasing the number of renewable energy sources integrated into the grid requires a strategy to manage and control the energy flow to maintain and improve the reliability and quality of the power supply [1,12]. With the connection of a large number of small-capacity distributed generations such as PV systems and wind turbines, the modern distribution networks are undergoing significant changes [6,13].

The photovoltaic system used for power generation involves various components whose operational behavior varies. To be more precise, solar intensity is time-varying and weather-dependent, hence, constant power generation is not possible throughout the system operation. Internet of Things (IoT) can solve the most complex issues that present day science and engineering systems would face,

including monitoring the energy flow in the system. IoT is used to achieve energy efficiency in PV systems and to have remote transmission of data from plant to supervision server [6,14,15]. This indirectly affects the functioning of other system components like power converter voltage levels, battery state of charge, energy demands by loads, etc. Sometimes, dust accumulation and other environmental conditions may also result in poor performance of the PV system. When interconnecting a renewable energy-based generator, the grid interface needs to be designed to meet applicable regulatory requirements set by the local utility. To verify the requirements about protection, control, and power quality, detailed simulation studies need to be performed. Time-domain simulation with Electromagnetic [12] transient (EMT) programs is a powerful method that can be used for studies involving controller tuning, protection setting, power quality investigations, and system validation [16].

Integration of a large number of PV units into the distribution grid raises power quality issues as the PV systems depend on weather conditions and generate varying ranges of active power therefore causing voltage fluctuations. The fluctuations of real power due to the power electronics interface between the PV system and distribution grid can cause voltage fluctuations in the system where the PV plant is installed [17]. To investigate the system control of power flow and voltage level at the grid interface, a detailed model of a grid-connected single-phase PV system associated with a control design scheme is presented.

2. SYSTEM MODELING AND CONTROL DESIGN

The designed PV model consists of several PV arrays, DC-DC power converter interface, DC bus capacitor, maximum power point tracker (MPPT) control scheme, voltage source converter module, and power distribution grid model as shown in Fig. 1a.

2.1. PV array

The PV array power output depends on the irradiation and temperature. The DC-DC converter or boost converter is an interface between the PV system and the VSC to adjust and increase the DC-link current based on the reference power generated by the MPPT [18,19]. The VSC controls the DC voltage from the DC-bus link and maintains its reference [25] magnitude. If the irradiation of the PV array increases, the power output of the PV is increased and the voltage of the DC-link is also increased. This condition will increase the boost converter duty cycle and draw more current from the PV array, therefore regulating the DC-link voltage and meeting the reference power from

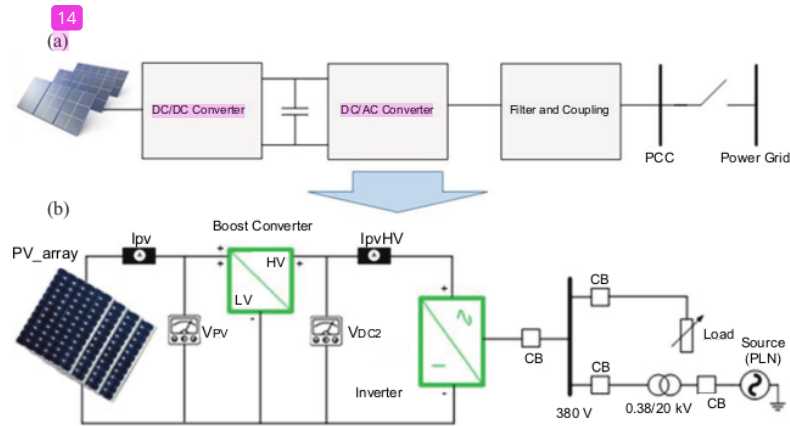

Fig. 1. Grid-connected PV system with a two-stage converter.

the MPPT. For simulation purposes, Fig. 1a is designed in PSCAD/EMTDC software as shown in Fig. 1b.

PV modules consisting of several PV cells, in turn, form a PV solar panel as shown in Fig. 2. PV cells are connected in series and parallel to provide more power. In this paper, a model of a PV module system consisting of ten (series) by four (parallel) configurations is presented. Characteristic such as $V-I$ and $P-V$ can be obtained. E_a (kV) is plotted against I_a (in kA), E_a (kV) is plotted against P (MW).

2.2. Boost converter

In Fig. 1, the DC power output from the PV system is fed to a boost converter or up chopper. The chopper serves to raise the voltage from the source level (low) to the output level (high). The voltage appearing across the low voltage terminal of the boost converter is a train of pulses and has a DC component and ripple [8,11]. The ripple will be substantially absorbed across the inductance. The switching times of the static switches that constitute the boost converter determine the voltage conversion ratio of the boost

converter. Therefore, it is easy to vary the voltage conversion ratio smoothly and continuously by adjusting voltage input into the boost converter control circuit, to suitably modify the timing of the switching control pulses to the power switching elements. Also shown in Fig. 1 is a filter circuit to reduce the current ripple flowing into the inverter circuit. The reference power is compared to the DC-link power and the error signal to generate the duty cycles through a PI controller as shown in Fig. 3.

$$L_{dc} = \frac{V_{PV}(V_{DC} - V_{PV})}{\Delta I f_{DC} V_{DC}}. \quad (1)$$

The capacity of the boost converter is determined based on the PV system capacity and the switching frequency, f_{DC} . The inductor, L_{DC} , is to limit the current ripple, ΔI , and can be calculated as given in Eq. (1).

2.3. DC-link capacitor

The DC voltage output of the boost converter is filtered by the DC-link capacitor. An intermediate filter circuit

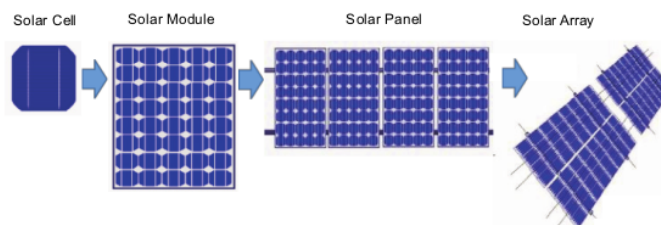

Fig. 2. Photovoltaic (PV) system.

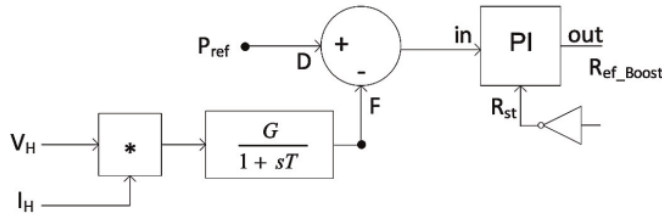

Fig. 3. Power controller.

will further minimize the ripple in the DC-link voltage, which will be connected after the PV array power output. An expression for the peak-to-peak voltage ripple, ΔV_{DC} , of the DC-link, can be calculated using Eq. (2), where P_G is the real power injected into the grid, C_{DC} is the DC-link capacitor and ω is the fundamental angular frequency of the grid voltage. V_{DC} is measured based on the PV system and boost converter capacity.

$$\Delta V_{DC} = \frac{P_G}{C_{DC} V_{DC} \omega} \tag{2}$$

2.4. Voltage source converter (VSC)

The voltage source converter is a full-bridge converter that uses semiconductor devices and has a switching control circuit providing necessary pulses to turn on and off each static switching element with the correct timing and sequences. These switches function by insulated gate bipolar transistor (IGBT) or gate turn-off transistor (GTO) that are repetitively operated in such a way as to control the inverter operation to generate the sinusoidal voltage at its output terminal. For obtaining independent control of active and reactive power at both ends, a specific vector control strategy is implemented to operate the VSCs [20]. This ability of the VSC makes it suitable for connection to weak AC networks, i.e., without local voltage sources. The VSC system is supplying or absorbing reactive power to or from the grid.

2.5. LCL filter

The LCL filter components of the PV system are used to replace the conventional L-filter to eliminate the high order harmonics of current output and also meet the IEEE 519-1992 standard [21]. LCL filters have been used in grid-connected inverters and pulse-width modulated active rectifiers as shown in Fig. 4. The LCL filter should reduce the expected current ripple and provide better attenuation.

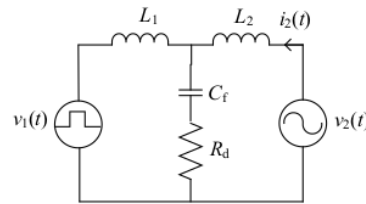

Fig. 4. LCL filter and its parameter.

2.6. Maximum power point tracker (MPPT)

In order to operate the PV array to its maximum power, a MPPT is implemented. The boost converter will vary the voltage level to the knee point to drive the PV system to work at the optimum level. Figure 5 shows the configuration of the MPPT system. The PI controller output is to compare with a high-frequency sawtooth waveform to generate a high-frequency duty cycle.

Based on the reference power generated by the MPPT system, the DC-link current of the PV array is regulated by the boost converter as seen in Fig. 1, while the DC-link voltage is controlled by the voltage source converter. Both of these parameters are to maintain their reference value.

3. RESULTS AND DISCUSSION

The grid-connected PV system model was developed and simulated in PSCAD/EMTDC software for illustration purposes. Simulation studies were performed to evaluate the model design of the PV system based on system parameters. A PV system of 3 kW was constructed as a part of the whole system. The control devices such as MPPT, boost converter, and VSC were installed.

The first step of the simulation was performing the variation of resistance (R) over a certain time, and identifying the impact in the terminal voltage E_a , current I_a ,

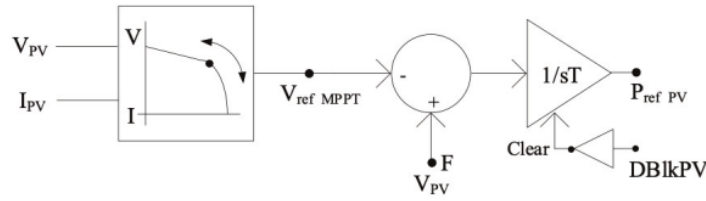

Fig. 5. MPPT controller.

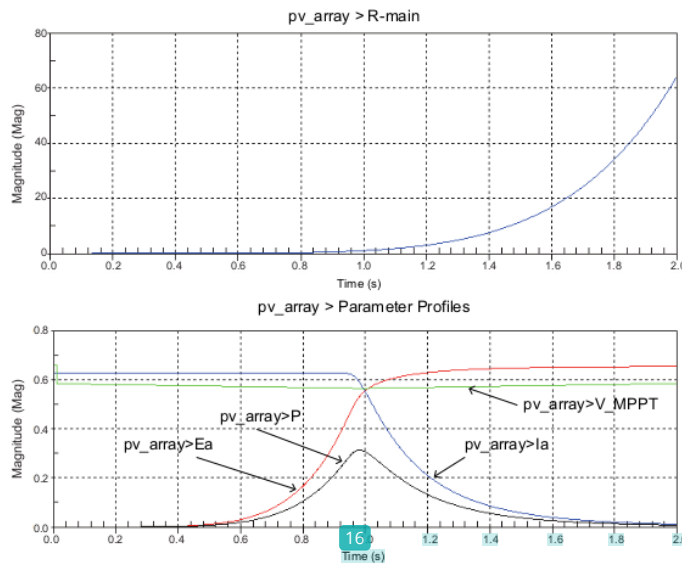

Fig. 6. Variation of R versus E_a , I_a , P , and V_{MPPT} .

33 ver P , and the MPPT voltage. The results are presented in Fig. 6. As can be seen from the figure the V_{MPPT} voltage is in the range of 0.55 kV and 0.59 kV for this photovoltaic system.

It is evident that the current and power decreased while the resistance increased.

The PV array characteristics such as voltage-current and active power-voltage characteristics are plotted in E_a versus I_a and E_a versus P as shown in Fig. 7.

The DC-link voltage as indicated by Eq. (1) shows that the DC voltage generated increased to 1.5 in magnitude and reduced to average value in 10 seconds. The DC current as indicated by Eq. (2) increased to 0.3 in magnitude and sloped up to 10 seconds. The power profile generated from the boost converter is shown in Figs 8, 9 and 10, respectively.

6

The load active and reactive power profiles of the grid bus are given in Fig. 11, while active and reactive power generated by the VSC and injected into the grid bus are indicated in Fig.12.

22

The active and reactive power of the grid bus is shown in Fig. 13. It can be seen that the active power decreased to -0.27 per unit and suddenly increased at 3.5 seconds to -0.12 per unit. This indicates the VSC absorbed the power from the grid bus. The reactive power decreased to -0.10 per unit and increased to -0.01 per unit after 3.5 seconds.

The grid phase currents are shown in Fig. 14. The currents increased during the switching event for about 3 seconds and became a steady-state even though the current I_{grid1} reached the steady-state condition 5 seconds later.

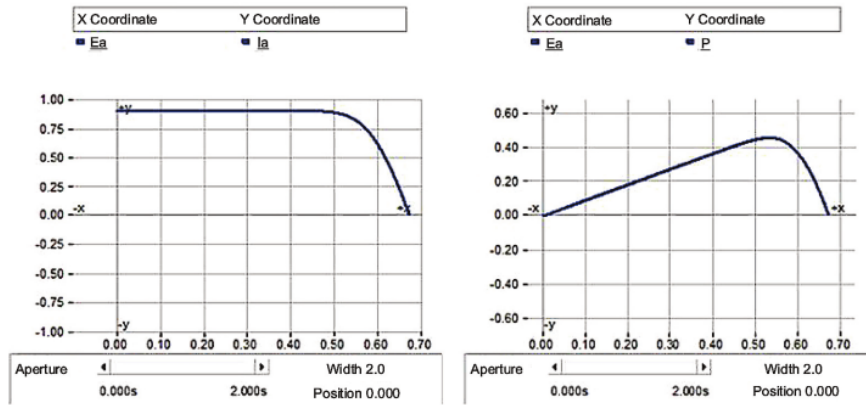

Fig. 7. The $V-I$ and $P-V$ characteristics of the PV system.

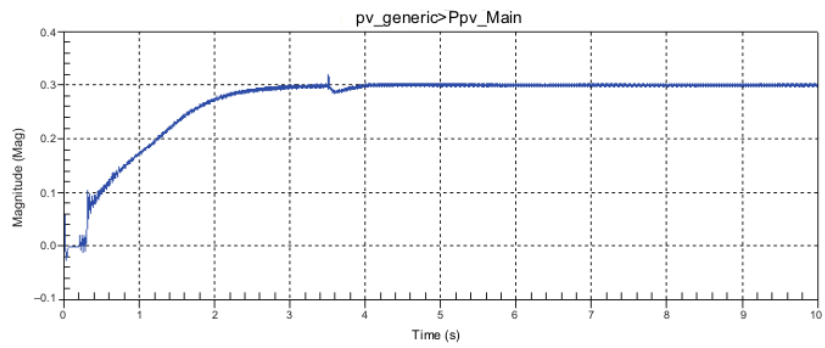

Fig. 8. DC voltage of the boost converter.

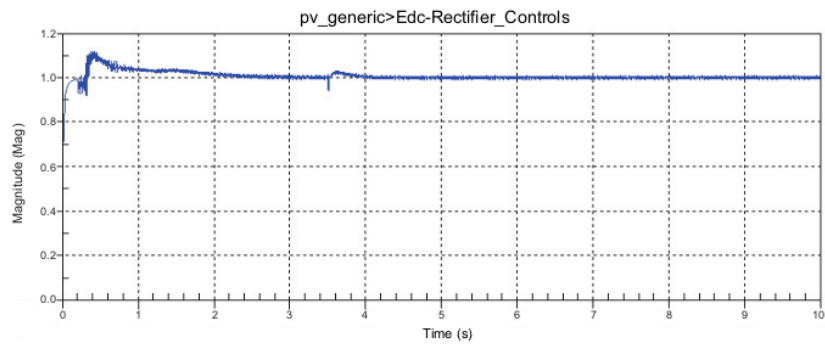

Fig. 9. DC current of the boost converter.

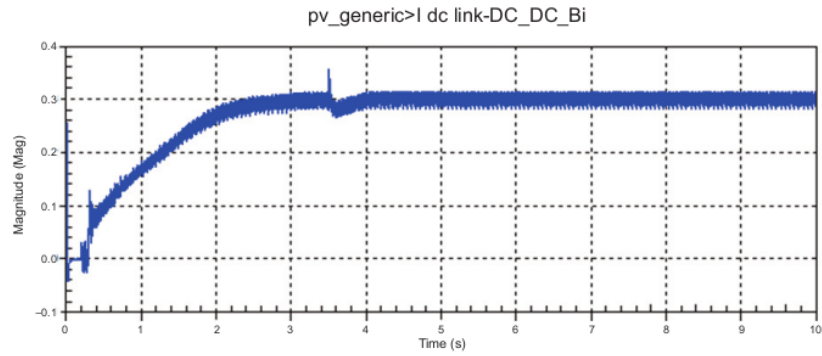

Fig. 10. DC power of the boost converter.

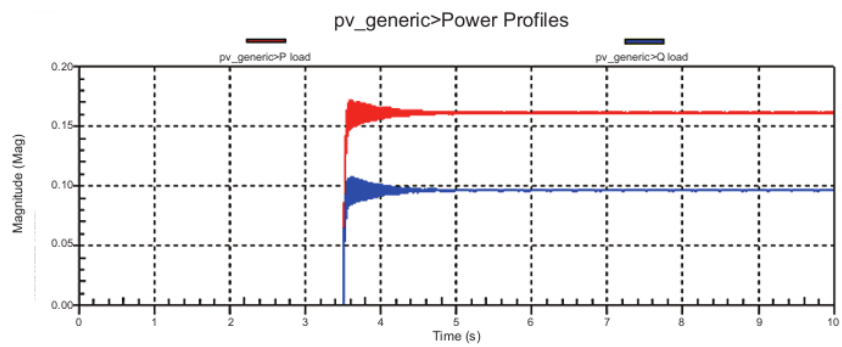

Fig. 11. The load power profiles.

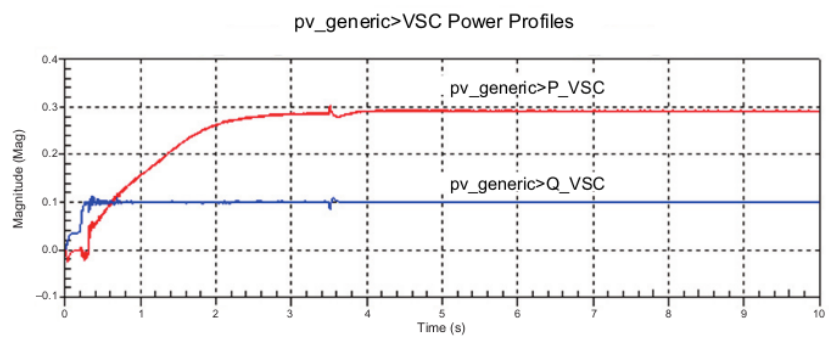

Fig. 12. The load power profiles.

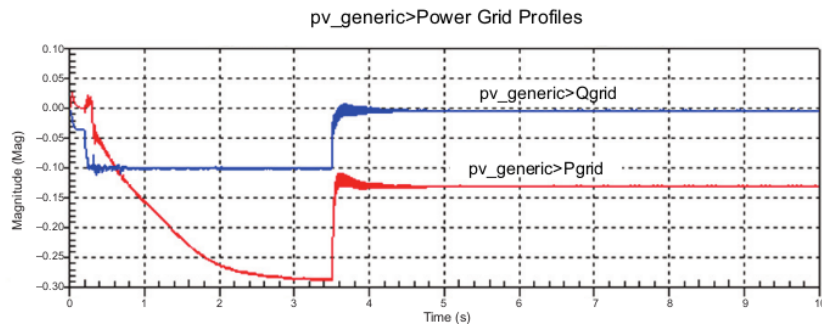

Fig. 13. Power grid profiles of the system.

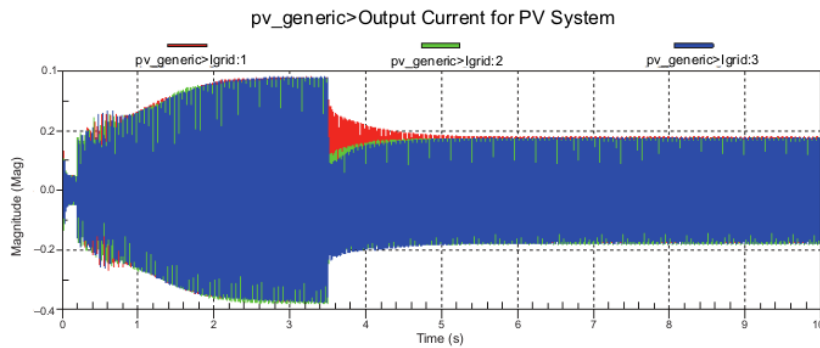

Fig. 14. Current grid profiles.

4. CONCLUSION

A model of grid-connected photovoltaic (PV) system associated with DC-DC and DC-AC controllers is presented. The designed and developed model is evaluated with simulated studies. The voltage output from the boost converter contains ripple and can be smoothed and stabilized through the DC-link capacitor. Since the output voltage of the VSC contains harmonics, an LCL filter circuit to compensate for the harmonics is implemented. The active and reactive power from the voltage source converter to the grid can be increased by controlling the MPPT algorithm and operating the VSC at the maximum lagging power factor.

ACKNOWLEDGEMENTS

The authors would like to thank the Directorate of Research and Community Service, Directorate General

of Research Strengthen and Development, Ministry of Education, Culture, Research and Technology for financial support for the fiscal year 2021, under contract No. 238/E4.1/AK.04.PT/2021. This research was funded by project No. T190087MIMV and the European Commission through EU-India Project MLTKT19481R "Identifying best available technologies for decentralized wastewater treatment and resource recovery for India" and Estonian Environmental Investment Centre (EIC) Project SLTKT20427 "Sewage sludge treatment from heavy metals, emerging pollutants and recovery of metals by fungi". Financial support was also received from University of Tartu Development fund PLTKT ARENG53 and INTERREG project "Improving quality of BSR waters by advanced treatment processes". The publication costs of this article were covered by the Estonian Academy of Sciences.

REFERENCES

- Krismanto, A. U., Khairullah, H. A., Sulistiawati, I. B., Lomi, A. and Sarkar, D. Probabilistic static voltage stability of power system with integration of PV generators using Monte Carlo simulations. *Proc. Pak. Acad. Sci.: A*, 2021, **58**(S), 73–84. [http://doi.org/10.53560/PPASA\(58-sp1\)735](http://doi.org/10.53560/PPASA(58-sp1)735)
- Abdullah, K., Uyun, A. S., Soengeng, R., Suherman, E., Susanto, H., Setyobudi, R. H. et al. Renewable energy technologies for economic development. *E3S Web Conf.*, 2020, **188**(00016), 1–8. <http://doi.org/10.1051/e3sconf/202018800016>
- Rudationo, C. B., Novianto, B., Yandri, E., Susanto, H., Setyobudi, R. H., Uyun, A. S. et al. Techno-economic analysis of rooftop photovoltaic system (RPVS) using thin-frameless solar panels for household customers in Indonesia. *Proc. Pak. Acad. Sci.: A*, 2021, **58**(S), 131–139. [http://doi.org/10.53560/PPASA\(58-sp1\)750](http://doi.org/10.53560/PPASA(58-sp1)750)
- Lomi, A. The role of renewable energy: Sumba Iconic Island, an implementation of 100 percent renewable energy by 2020. In *Proceedings of the 2nd International Conference on Electrical Systems, Technology and Information (ICESTI), Bali, Indonesia, 9–12 September 2015*. Springer, 2016, 173–184. https://doi.org/10.1007/978-981-287-988-2_19
- World Resource Institute. *Statement: Indonesia submits new 2030 climate targets and first long-term climate strategy*. <https://www.wri.org/news/statement-indonesia-submits-new-2030-climate-targets-and-first-long-term-climate-strategy> (accessed 2021-08-17).
- Bangun, N., Abdullah, K., Uyun, A. S., Yandri, E., Nur, S. M., Susanto, H. et al. Smart micro-grid performance using renewable energy. *E3S Web Conf.*, 2020, **188**, 1–11. <https://doi.org/10.1051/e3sconf/202018800005>
- Soonmin, H., Lomi, A., Okoroigwe, E. C. and Urrego, L. R. Investigation of solar energy: The case study in Malaysia, Indonesia, Colombia, and Nigeria. *Int. J. Renew. Energy Res.*, 2019, **9**(1), 86–95.
- Rodriguez, C. and Bishop, J. D. Organic architecture for small- to large-scale photovoltaic power stations. *IEEE Trans. Ind. Electron.*, 2009, **56**(11), 4332–4343. <https://doi.org/10.1109/TIE.2009.2023642>
- Carrasco, J. M., Bialasiewicz, J. T., Portillo, G. R. C. and León, J. I. Power electronic systems for the grid integration of renewable energy sources: a survey. *IEEE Trans. Ind. Electron.*, 2006, **53**(4), 1002–1016. <https://doi.org/10.1109/TIE.2006.878356>
- Rohiem, N. H., Soeprijanto, A., Putra, D. F. U., Syai'in, M., Sulistiawati, I. B., Zahoor, M. and Shah, L. A. Resolving economic dispatch with uncertainty effect in microgrids using hybrid incremental particle swarm optimization and deep learning method. *Proc. Pak. Acad. Sci.: A*, 2021, **58**(S), 119–129. [http://doi.org/10.53560/PPASA\(58-sp1\)762](http://doi.org/10.53560/PPASA(58-sp1)762)
- Bahrman, M. P., Johansson, J. G. and Nilson, B. A. Voltage source converter transmission technologies: the right fit for the application. *IEEE Xplore*, 2003, **3**, 1840–1847. <http://doi.org/10.1109/PES.2003.1267441>
- Pielahn, M., Mudunkotuwa, K. and Muthumuni, D. Modeling solar converters for harmonic and resonance studies. *Int. J. Smart Grid Sust. Energy Tech.*, 2017, **1**(1), 10–13. <https://doi.org/10.36040/ijsgset.v1i1.181>
- Iwamura, K., Nakanishi Y., Lewlompaisarl, U., Estoperez, N. and Lomi, A. Facility planning optimization platform, ggod, for expandable cluster-type micro-grid installations and operations. *Proc. Pak. Acad. Sci.: A*, 2021, **58**(S), 101–107. [http://doi.org/10.53560/PPASA\(58-sp1\)742](http://doi.org/10.53560/PPASA(58-sp1)742)
- Kumar, N. M., Atluri, K. and Palaparthy, S. Internet of things (IoT) in photovoltaic systems. In *Proceedings of the National Power Engineering Conference (NPEC), Madurai, India, 9–10 March, 2018*. IEEE, 2018, 1–4. <http://doi.org/10.1109/NPEC.2018.8476807>
- Yandri, E., Setyobudi, R. H., Susanto, H., Abdullah, K., Nugroho, Y. A., Wahono, S. K. et al. Conceptualizing Indonesia's ICT-based energy security tracking system with detailed indicators from smart city extension. *E3S Web Conf.*, 2020, **188**(00007). <https://doi.org/10.1051/e3sconf/202018800007>
- Rajapakse, A., Muthumuni, D. and Perera, N. Grid integration of renewable energy systems. In *Renewable Energy* (Hammons, T. J., ed.). IntechOpen, London, 2009, 109–131. <https://doi.org/10.5772/7375>
- Krismanto, A. U., Mithulananthan, N. and Lomi, A. Dynamic droop control in microgrid for stability enhancement considering RES variation. In *Proceedings of the 2017 IEEE PES Innovative Smart Grid Technologies Conference Europe (ISGT-Europe), Turin, Italy, 26–29 September 2017*. IEEE, 2017, 1–6. <https://doi.org/10.1109/ISGTEurope.2017.8260149>
- Sahan, B., Vergara, A. N., Henze, N., Engler, A. and Zacharias, P. A single-stage PV module integrated converter based on a low-power current-source inverter. *IEEE Trans. Ind. Electron.*, 2008, **55**(7), 2602–2609. <https://doi.org/10.1109/TIE.2008.924160>
- Kjaer, S. B., Pedersen, J. K. and Blaabjerg, F. A review of single-phase grid-connected inverters for photovoltaic modules. *IEEE Trans. Ind. Appl.*, 2005, **41**(5), 1292–1306. <https://doi.org/10.1109/TIA.2005.853371>
- Imad, A. E., Yury, N. P. and Mostafa, M. K. Incorporation of a step-up boost converter in photovoltaic power systems for DC applications. *Int. J. Smart Grid Sust. Energy Tech.*, 2017, **1**(2), 57–60. <https://doi.org/10.36040/ijsgset.v1i2.213>
- IEEE. *Std 519-1992 IEEE recommended practices and requirements for harmonic control in electrical power systems*. https://edisplinas.usp.br/mod_resource/content (accessed 2021-08-20).

Vooluvõrku ühendatud fotogalvaanilise süsteemi mudel

Abraham Lomi, Meita Rumbayan, Yasuke Nakanishi, Kazuaki Iwamura, Noel Regis Estoperez, Udom Lewlomphaisarl, Erkata Yandri, Muhammad Zahoor ja Ivar Zekker

Taastuenergia nagu päikese- ja tuuleenergia kasutamine on jätkusuutlikuks arenguks ja elektri hinnaga võitlemiseks hädavajalik. Uurimistöös loodi mudel fotogalvaanilisest (*photogalvanic* – *PV*) süsteemist, mis on varustatud alalis- ja vahelduvvoolu kontrollritega ja ühendatud vooluvõrku. Artiklis esitatakse katsetatud alalis- ja vahelduvvoolu kontrollereid ning erinevaid protsessiskeeme. Projekteeritud ja välja töötatud mudelite abil hinnatakse simuleeritud uuringute raames *PV* süsteemi toimimist. Võimendusmuunduri väljuvaid voolukõikumisi saab ühtlustada ja stabiliseerida alalisvoolu kondensaatori abil. Kuna väljundpinges esinevad kõikumised, saab kasutada nende kompenseerimiseks *LCL* sagedusfiltrit. Aktiiv- ja reaktiivvõimsust pingeaallika muundurilt vooluvõrku suunamisele saab suurendada erinevaid algoritme juhtides, mida töös ka simuleeriti.

ORIGINALITY REPORT

12%

SIMILARITY INDEX

9%

INTERNET SOURCES

10%

PUBLICATIONS

4%

STUDENT PAPERS

PRIMARY SOURCES

- 1 Ioinovici, . "Classical DC-DC PWM Hard-Switching Converters", Power Electronics and Energy Conversion Systems Fundamentals and Hard-switching Converters, 2013. <1 %
Publication

- 2 Submitted to The University of Manchester <1 %
Student Paper

- 3 hkjoss.com <1 %
Internet Source

- 4 vbn.aau.dk <1 %
Internet Source

- 5 www.oecd-ilibrary.org <1 %
Internet Source

- 6 www.provedor.nuca.ie.ufrj.br <1 %
Internet Source

- 7 ebin.pub <1 %
Internet Source

- 8 www.ppaspk.org <1 %
Internet Source

9	"Smart Energy Empowerment in Smart and Resilient Cities", Springer Science and Business Media LLC, 2020 Publication	<1 %
10	Mohammad Ahmadi, Haidar Samet, Teymoor Ghanbari. "Series Arc Fault Detection in Photovoltaic Systems Based on Signal-to-Noise Ratio Characteristics Using Cross-Correlation Function", IEEE Transactions on Industrial Informatics, 2020 Publication	<1 %
11	S. Rees. "New Cascaded Control System for Current-Source Rectifiers", IEEE Transactions on Industrial Electronics, 2005 Publication	<1 %
12	l-tech.co.il Internet Source	<1 %
13	www.tntech.edu Internet Source	<1 %
14	"Fault Analysis and its Impact on Grid - connected Photovoltaic Systems Performance", Wiley, 2022 Publication	<1 %
15	Submitted to University of Melbourne Student Paper	<1 %
16	doczz.net Internet Source	<1 %

17

Yang Wang, Haimeng Chen, Bo Gao, Xianyong Xiao, Ricardo Torquato, Fernanda C. L. Trindade. "Harmonic resonance analysis in high - renewable - energy - penetrated power systems considering frequency coupling", Energy Conversion and Economics, 2022

Publication

<1 %

18

M. M. Zakaria Moustafa, S. Filizadeh. "Electromagnetic Transient Simulation of a Back-to-Back Voltage Source Converter Based Transmission Scheme", 2007 Canadian Conference on Electrical and Computer Engineering, 2007

Publication

<1 %

19

Muhammad Zahoor, Azmat Ullah, Sultan Alam, Mian Muhammad, Roy Hendroko Setyobudi, Ivar Zekker, Amir Sohail. "Novel Magnetite Nanocomposites (Fe₃O₄/C) for Efficient Immobilization of Ciprofloxacin from Aqueous Solutions through Adsorption Pretreatment and Membrane Processes", Water, 2022

Publication

<1 %

20

Pawasuth Saengdee, Chamras Promptmas, Surachoke Thanapitak, Awirut Srisuwan et al. "Optimization of 3-aminopropyltriethoxysilane functionalization on silicon nitride surface for biomolecule immobilization", Talanta, 2020

<1 %

21

Submitted to University of Newcastle

Student Paper

<1 %

22

Submitted to University of Sheffield

Student Paper

<1 %

23

journal.binus.ac.id

Internet Source

<1 %

24

Karsam KARSAM, Muslichah Erma WIDIANA, Anak Agung Sagung Alit WIDYASTUTY, Kusni HIDAYATI. "Preservation, Standardization and Information Technology 4.0 of Traditional Gedog Tuban Batik to be Competitive in Marketing During COVID - 19", Theoretical and Practical Research in the Economic Fields, 2022

Publication

<1 %

25

aip.scitation.org

Internet Source

<1 %

26

crossmark.crossref.org

Internet Source

<1 %

27

repository.kulib.kyoto-u.ac.jp

Internet Source

<1 %

28

www.bioflux.com.ro

Internet Source

<1 %

29 Leon, A.E., J.A. Solsona, and M.I. Valla. <1 %
"Control strategy for hardware simplification
of voltage source converter-based power
applications", IET Power Electronics, 2011.
Publication

30 Submitted to Middle East Technical University <1 %
Student Paper

31 b2find.eudat.eu <1 %
Internet Source

32 ejournal.undip.ac.id <1 %
Internet Source

33 www.koreascience.or.kr <1 %
Internet Source

Exclude quotes On

Exclude matches < 10 words

Exclude bibliography On