

Design and Simulation “Ha”- Slot Patch Array Microstrip Antenna for WLAN 2.4 GHz

by Kartiko Ardi Widodo

Submission date: 06-May-2024 07:26PM (UTC-0700)

Submission ID: 2372881079

File name: ion_Ha_-Slot_Patch_Array_Microstrip_Antenna_for_WLAN_2.4_GHz.pdf (1.38M)

Word count: 4449

Character count: 37087



Design and Simulation “Ha”-Slot Patch Array Microstrip Antenna for WLAN 2.4 GHz

Sotyohadi Sotyohadi^{1*}, I Komang Somawirata¹, Kartiko Ardi Widodo¹,
Son Thanh Phung², and Ivar Zekker³

¹Department of Electrical Engineering, National Institute of Technology (ITN) Malang,
Jl. Raya Karanglo Km. 2, Malang 65145, East Java, Indonesia

²Faculty of Electrical and Electronics Engineering (FEEE), Ho Chi Minh City University of
Technology and Education (HCMUTE), 01 Vo Van Ngan Street, Thu Duc District,
Ho Chi Minh City, Vietnam

³Institute of Chemistry, University of Tartu, Ravila 14a, 50411 Tartu, Estonia

Abstract: This paper presents a linear 1×2 “Ha ($n\mu$)”-slot patch array microstrip antenna. The proposed design of an array microstrip antenna is intended for Wireless Local Area Network (WLAN) 2.4 GHz devices. From the previous research concerning the single patch “Ha ($n\mu$)”-slot microstrip antenna, the gain that can be achieved is 5.77 dBi in simulation. This value is considered too small for an antenna to accommodate WLAN devices if compare to a Hertzian antenna. To enhance the gain of microstrip antenna, some methods can be considered using linear 1×2 patch array and T-Junction power divider circuit to have matching antenna impedance. The distances between two patches are one of the important steps to be considered in designing the patch array microstrip antenna. Thus, the minimum distance between the patch elements are calculated should be greater than $\lambda/2$ of the resonance frequency antenna. If the distance less than $\lambda/2$ electromagnetically coupled will occur, vice versa when it is to widen the dimension of the antenna will less efficient. Epoxy substrate Flame Resistant 4 (FR4) with dielectric constant 4.3 is used as the platform designed for the array antenna and it is analyzed using simulation software Computational Simulation Technology (CST) studio suite by which return loss, Voltage Standing Wave Ratio (VSWR), and gain are calculated. The simulation result showed that the designed antenna achieve return loss (S11) -25.363 dB with VSWR 1.1 at the frequency 2.4 GHz, and the gain obtained from simulation is 8.96 dBi, which is greater than 64.4 % if compared to the previous one. The proposed antenna design shows that increasing the number of patches in the array can technically improve the gain of a microstrip antenna, which can cover a wider area if applied to WLAN devices.

Keywords: CST Studio Suite, Flame Resistant 4, Return Loss (S11), T-junction, Voltage Standing Wave Ratio.

1. INTRODUCTION

Antenna can be classified as the transducer, which is able to transfer energy from one form to another [1–3]. From this meaning, the antenna has a very important role in wireless telecommunication, because the antenna is a metal conductor that can radiate and harvest radio waves [4]. Along with the rapid development of wireless communication devices, the need for an antenna in a small size, compact, lightweight, and the ability to work in a wide band frequency is required. One type of antenna which suitable for this requirement is a

microstrip antenna [5]. Besides some advantages possessed by microstrip antenna, there are also disadvantages such as poor efficiency, narrow bandwidth, and low gain, which becomes a major problem for mobile communication designers [6]. From previous research on the single patch “Ha ($n\mu$)”-slot microstrip antenna, the gain obtained is 5.77 dBi for simulation, and the gain from the antenna after fabrication and measurement it reaches only 3.576 dBi [7]. This value is relatively low if compared to other types of antenna such as Hertzian antenna [8]. To accommodate WLAN devices, the gain of the single patch microstrip

Received: August 2021; Accepted: November 2021

*Corresponding Author: Sotyohadi Sotyohadi <sotyohadi@lecturer.itn.ac.id>

antenna should be improved, thus it can operate in the 2.4 GHz frequency and can cover a wider area [9]. Some considerable methods and techniques can be used to overcome this problem. One method that has been utilized to improve the gain of microstrip antenna is the patch arrangement in an array [10]. An antenna array is a combination of several connected antennas arranged to form a single antenna [11]. The main benefits of array microstrip antenna are the increase of overall gain, providing reception of diversity, and interference canceling from a common set of directions [9].

In this research a linear 1×2 "Ha (μm)"-slot patch array microstrip antenna is designed and simulated, as the development and improvement of a single patch "Ha (μm)"-slot microstrip antenna [7]. Thereafter, the design was simulated using CST studio suite student version software to have the result of return loss (S11), VSWR, and antenna gain.

2. MATERIALS AND METHODS

2.1 "Ha (μm)"-slot Microstrip Antenna

The linear 1×2 "Ha (μm)"-slot patch array microstrip antenna is designed to work for frequency 2.4 GHz. This frequency is an ISM (Industrial, Scientific, and Medical) which is not regulated and can be freely used [12]. Material parameters for the simulation are set for the dielectric substrate FR4, which has the dielectric permittivity constant (ϵ_r) = 4.3 and the substrate thickness (h) = 1.5 mm.

The basic design of the linear 1×2 "Ha (μm)"-slot patch array microstrip antenna is based on a single patch "Ha (μm)"-slot microstrip antenna, which can be shown in Figure 1 [7].

The dimension and annotation of the single patch microstrip antenna can be explained in the Table 1 [7].

2.2 Patch Array Microstrip Antenna Design

Based on the single patch "Ha (μm)"-slot microstrip antenna design, the "Ha (μm)"-slot patch array was developed in a corporate feed network. The design of the two-element microstrip patch array antenna with the "Ha (μm)"-slot can be shown in Figure 2.

In order to achieve the design shown in Figure 2, three steps need to be carried out. Namely, obtaining the distance between two patches, the width dimensions, and the length of the microstrip antenna patch array two-element.

The first step is to determine the distance between patch array elements. The minimum distance between the elements for the patch array is $\lambda/2$ of the resonance frequency antenna in Equation (1) [13].

$$d = \lambda/2 = v/(2 \times f) \quad (1)$$

Where d is the distance between patches, v is the velocity of light in free space ($3 \times 10^8 \text{ m s}^{-1}$), and f is the resonance frequency of the antenna.

The estimation of the minimum distance between elements is due to the effect of electromagnetically coupled which occurs if the distance between elements is less than $\lambda/2$. However, the microstrip antenna substrate dimension will result in less efficiency if the distance is too wide.

The second step is to determine the width of the ground plane (W_g) microstrip patch array antenna of two elements. The W_g can be calculated by Equation (2):

$$W_g = (2 \times c) + (2 \times W_p) + d \quad (2)$$

Where W_p is the width of the patch, c is the distance between the edge of the substrate and the patch, and d is the distance between patches.

The third step is to determine the length of the ground plane (L_g). The L_g can be calculated with the consideration of the T-Junction dimension in Equation (3). To ease the calculations of dimension T- Junction, notation #1 to #6 is added, which is shown in Figure 2.

$$L_g = a + L_p + d' + L_{\#5} + (L - 0.6955) \quad (3)$$

Where a is the distance between the edge of the upper side of the microstrip antenna and the patch, L_p is patch length which both of them have the same length, d' is the length of the microstrip feed line which has an impedance of 50Ω , $L_{\#1}$ and $L_{\#5}$ are the T-junction lengths of the power divider and

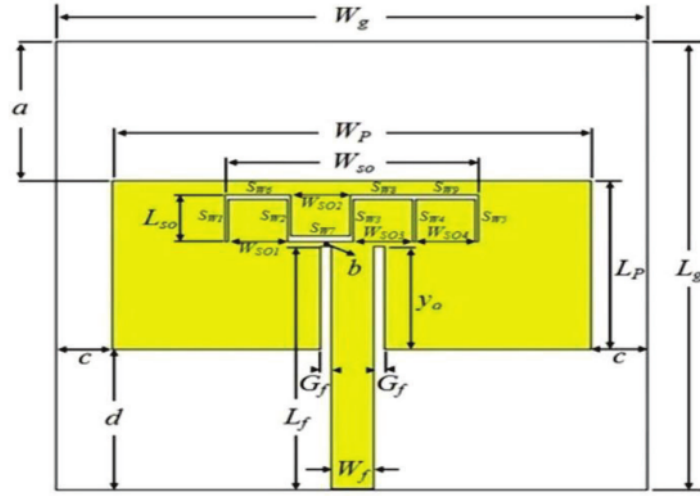

Fig. 1. Single patch “Ha”-slot microstrip antenna.

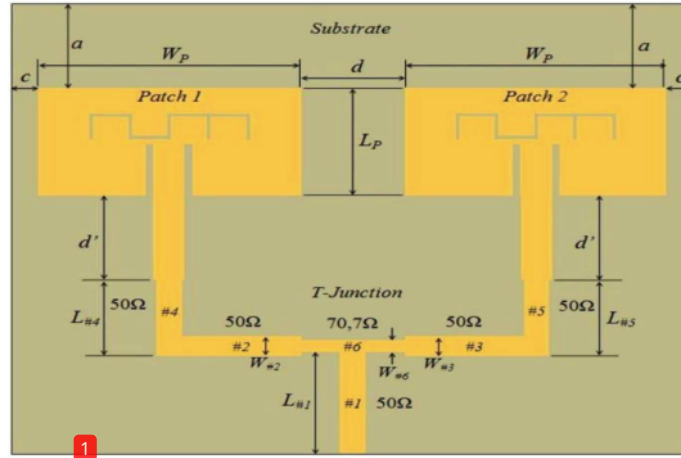

Fig. 2. 1 × 2 “Ha”-slot patch array microstrip antenna in a corporate feed.

matching impedance and 0.695 5 (mm) is the width difference between $L_{\#6} - L_{\#2}$ or $L_{\#6} - L_{\#3}$ because the width of $L_{\#2}$ and $L_{\#3}$ are equal.

2.3 T-Junction Power Divider

T-Junction is a method to connect the two patch microstrip antenna as a radiating element arranged in a row (corporate feed). The utilization of the T-Junction power divider method as a feeder and signal distributor to both patches is on the simplicity of matching by adjusting the position of the inset feeding and it is relatively easy to model it [14]. Figure 3 shows the standard form of the T-Junction power divider [14].

From the T-Junction design shown in Figure 3, the procedure to obtain the dimensions of the microstrip feed line for Power Divider are as follows:

- i. For designing two-element array or 1 × 2 patch array microstrip antenna arranged incorporate feed, a power divider is needed to connect the two elements of the microstrip antenna array with a transmission line, which generally has a 50 Ω impedance. To calculate both impedance matching can be obtained using Equation (4) [15].

$$Z = Z_0 \times \sqrt{N} \quad (4)$$

Table 1. Dimension of single patch “Ha”-slot microstrip antenna.

| Antenna Dimension | Annotation | Value (mm) |
|-------------------|--|------------|
| L_p | Patch Length | 18 |
| W_p | Patch Width | 38.393 4 |
| L_g | Ground plane Length | 48 |
| W_g | Ground plane Width | 47.393 4 |
| L_f | Microstrip feed line Length | 26 |
| W_f | Microstrip feed line Width | 3.363 9 |
| G_f | Inset feed Gap | 0.9 |
| y_o | Inset feed line Length | 11.035 6 |
| a | Distance between top edge with patch | 15 |
| b | Gap between slot with microstrip feed line | 0.464 4 |
| c | Distance between side edge with patch | 4.5 |
| d | Distance between bottom edge with patch | 15 |

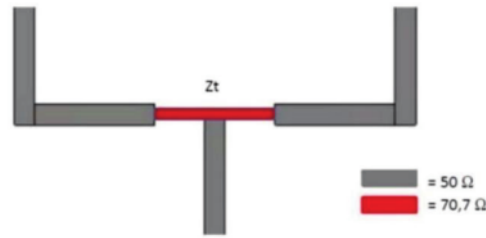
**Fig. 3.** T-Junction power divider.

Where Z is the required impedance value according to the number of microstrip antenna element arrays, Z_0 is the input impedance of the microstrip (Z_{in}) antenna, and N is the number of elements or arrays of microstrip antennas.

- ii. After the value of Z is obtained, the next step is to calculate the dimensions of the microstrip line input impedance Z_{in} . The width (W) and length (L) of the microstrip line 50Ω can be calculated. Start calculating the susceptance (B) [2] of the microstrip line using Equation (5).

$$B = (60 \times \pi^2) / (Z_0 \times \sqrt{\epsilon_r}) \quad (5)$$

Where B is the value of susceptance, π is a constant value of 3.14, Z_0 is the impedance of the transmission line and the 50Ω antenna channel (Z_{in}) and ϵ_r is the relative permittivity of the substrate material of the antenna.

After calculating the value of B , the next step is calculating the width (W) [4] of the power divider by using Equation (6).

$$W = \frac{2h}{\pi} \left\{ B - 1 - \ln(2B - 1) + \frac{\epsilon_r - 1}{2 \cdot \epsilon_r} \left[\ln(B - 1) + 0.39 - \frac{0.61}{\epsilon_r} \right] \right\} \quad (6)$$

- iii. Length (L) of impedance 50Ω microstrip line can be obtained with Equation (10). However, before calculating the length of the microstrip line 50Ω , the ratio of the width microstrip feed line to the thickness of the substrate (W/h) should be examined by Equation (7) [4].

$$W/h > 1$$

If the requirement of $W/h > 1$ is met, then the dielectric constant value (ϵ_{eff}) can be calculated using Equation (7) as follows [24].

$$\epsilon_{eff} = \frac{(\epsilon_r + 1)}{2} + \frac{(\epsilon_r - 1)}{2} \left[\frac{1}{\sqrt{1 + 12 \left[\frac{h}{W} \right]}} \right] \quad (7)$$

As a result of the microstrip antenna effective area, the effective wavelength of the antenna is obtained using Equation (8):

$$\lambda_0 = v / f \quad (8)$$

Where, v is the velocity or speed of light in free space (v_0) 3×10^8 m s^{-1} and f is the resonance or operating frequency of the antenna in units (Hz) or cycle per second ($c s^{-1}$).

Moreover, the effective length (λ_g) of the microstrip antenna can be obtained by Equation (9).

$$\lambda_g = \lambda_0 / \sqrt{\epsilon_{eff}} \quad (9)$$

Finally, the length (L) of the microstrip feed line can be calculated in Equation (10) with an impedance of 50Ω . The effective length of the antenna is a quarter lambda ($\lambda/4$) of the effective wavelength, according to Equation (10).

$$L = \lambda_g / 4 \quad (10)$$

The microstrip line 70.7Ω can be obtained using the calculation in step 2 and step 3.

2.3 Proposed Antenna

The proposed design of the linear 1×2 "Ha ($n\pi$)"-slot patch array microstrip antenna is shown in Figure 4.

The calculation results obtained for ground plane length (L_g) as follows:

$$L_g = 15 + 18 + 15 + 17.2915 + (17.715 - 0.6955) \\ L_g = 82.311 \text{ mm}$$

The width of the ground plane (W_g) is obtained as follows:

$$W_g = (2 \times 45) + (2 \times 38.3934) + 62.5 \\ W_g = 229.2868 \text{ mm}$$

The dimension of Figure 4 and the power

divider is given in the following Table 2.

Besides the design of the patch array microstrip antenna, the antenna power divider becomes the essential part of the design. In order to have the matching impedance of both patch array microstrip antennas, it is necessary to calculate the value of the T-Junction power divider, which can be explained in four steps.

- i. Determine the impedance of power divider Z . From Equation (4) the value of required impedance for two elements can be obtained. If $Z_0 = 50 \Omega$, and the number of patch element $N = 2$, then the value of impedance Z is equal to:

$$Z = 50 \times \sqrt{2} = 70.71 = 70.7 \Omega$$

- ii. In this research, the relative permittivity ϵ_r of FR4 (epoxy) material generally varies from 4.3 to 4.4 (which then the value 4.3 is used for designed calculations) in Equation (6).

$$B = \frac{60 \times (3.14)^2}{50 \times \sqrt{4.3}} = \frac{591.576}{103.682} = 5.706$$

After calculating the value of B , the next step is calculating the width (W) [2] of the power divider by using Equation (6).

The FR4 thickness h of the substrate is 1.5 mm.

$$W = \frac{2 \times 1.5}{3.14} \left\{ 5.706 - 1 - \ln(2 \times 5.706 - 1) \right. \\ \left. + \frac{4.3 - 1}{2 \times 4.3} \left[\ln(5.706 - 1) + 0.39 - \frac{0.61}{4.3} \right] \right\}$$

$$W = 2.92 \text{ mm}$$

- iii. After the width (W) of the power divider is obtained, the next step is to examine the ratio between the width (W) and the height of the substrate using Equation (7).

$$\frac{W}{h} > 1$$

$$\frac{2.92}{1.5} = 1.9467 > 1$$

Because $W/h > 1$, the dielectric constant value (ϵ_{eff}) uses Equation (7) as follows [2]. Thus,

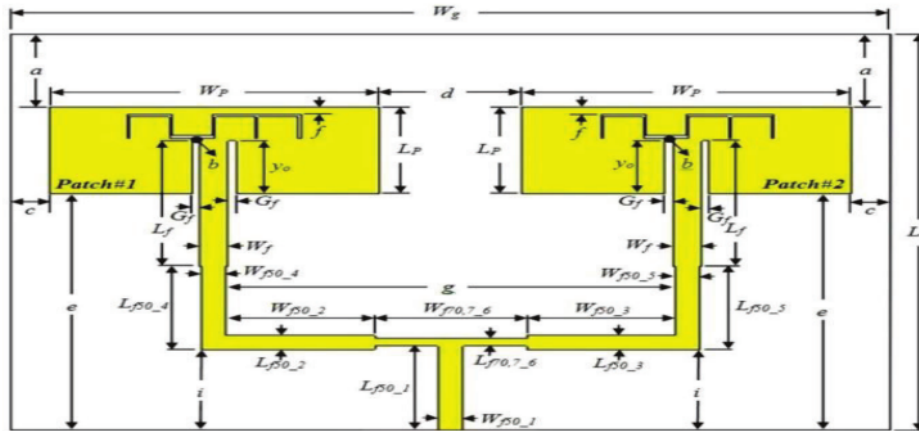

Fig. 4. 1×2 "Ha"-slot patch array microstrip antenna in a corporate feed.

Table 2. Dimension of 1×2 "Ha"-slot patch array microstrip antenna.

| Antenna Dimension | Annotation | Value (mm) |
|-----------------------|---|------------|
| L_g | Ground plane Length | 82.311 |
| W_g | Ground plane Width | 229.286 8 |
| $L_{f50_{1,2,3,4,5}}$ | Length 50Ω matching impedance 1, 2, 3, 4, 5 | 17.291 5 |
| $W_{f50_{1,2,3,4,5}}$ | Width 50Ω matching impedance 1, 2, 3, 4, 5 | 2.92 |
| $L_{f70.7_6}$ | Length 70.7Ω matching impedance 6 | 17.715 |
| $W_{f70.7_6}$ | Width 70.7Ω matching impedance 6 | 1.529 |

$$\epsilon_{eff} = \frac{(4.3 + 1)}{2} + \frac{(4.3 - 1)}{2} \left[\frac{1}{\sqrt{1 + 12 \left[\frac{1.5}{2.92} \right]}} \right]$$

$$\epsilon_{eff} = 2.65 + 1.65 [0.373 6] = 3.266 4$$

Soon after the value of the antenna effective area is obtained, then calculate the effective wavelength using Equation (8).

Therefore,

$$\lambda_0 = \frac{3 \times 10^8}{2.4 \times 10^9} = 0.125 \text{ mm}$$

$$\lambda_0 = 0.125 \text{ m} \times 1000 = 125 \text{ mm}$$

Built upon the result of effective wavelength, the effective length (λ_g) of the microstrip antenna can be calculated by applying Equation (9).

$$\lambda_g = 125 / \sqrt{3.266 4} = 69.166 \text{ mm}$$

Finally, the length (L) of the microstrip feed

line can be calculated in Equation (10).

$$L = 69.166 / 4 = 17.291 5 \text{ mm}$$

Finally, as a result for the dimension of 70.7Ω microstrip line is $W = 1.529 \text{ mm}$, $L = 17.715 \text{ mm}$.

3. RESULTS

The design of the linear 1×2 "Ha" (nm)"-slot patch array microstrip antenna is simulated on the CST Studio software. The patch array design in the simulation software is shown in Figure 5.

3.1 Return Loss

For a better quality of the antenna, the return loss (S11) should be less than -10 dB. Figure 6 shows the simulation result for return loss (S11) at a frequency of 2.4 GHz.

Figure 6 shows that the measurement results

for return loss (S11) patch array microstrip antenna is as low as -25.363, which means that the design of the antenna has a very small reflection or $VSWR \approx 1$.

3.2 Gain Antenna

In the following Figure 7, it shows the gain of the antenna.

Figure 7 above, shows that the result of gain measurement from simulation. In which the main lobe direction of the antenna is 25.0 degrees, and the maximum gain antenna is 8.96 dBi.

Therefore, the simulation comparison between a single "Ha (nm)"-slot patch and 1×2 "Ha"-slot patch array microstrip antenna is shown in Table 3.

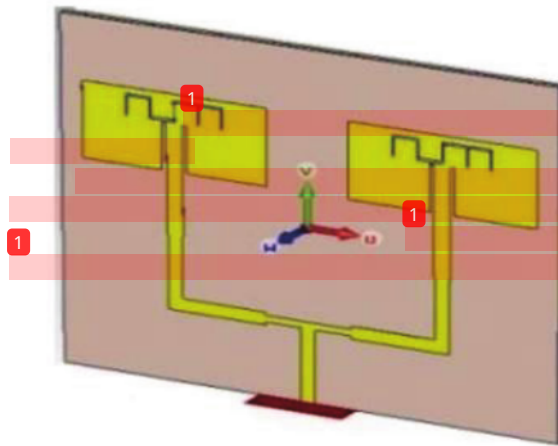

Fig. 5. Design and simulation 1×2 "Ha"-slot patch array microstrip antenna.

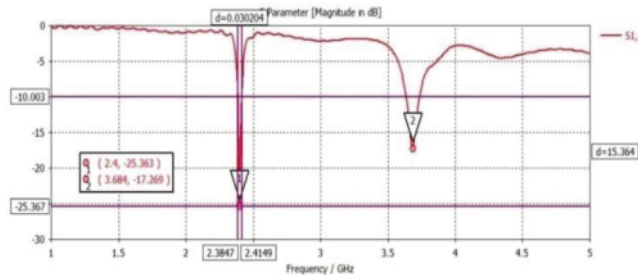

Fig. 6. The result of the return loss (S11) simulation.

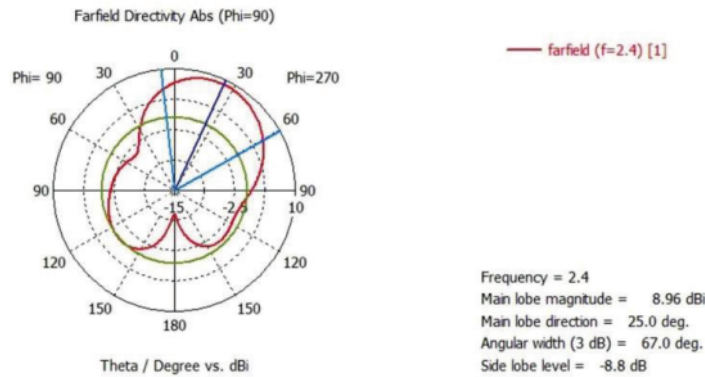

Fig. 7. The gain results in simulation.

Table 3. Simulation comparison single and patch array.

| Parameter | Single Patch | 1 x 2 Patch Array |
|---------------------------|--------------|-------------------|
| Resonance Frequency (GHz) | 2.408 | 2.4 |
| Return Loss / S11 (dB) | -23.8 | -25.363 |
| Gain (dBi) | 5.77 | 8.96 |

4. DISCUSSION

The research discusses the design and simulation of linear 1×2 "Ha (μm)"-slot patch array microstrip antenna. The simulation result can help to take the next step for fabrication. To ensure that the fabrication can be achieved successfully, calculation in designing the patch array antenna is needed. After obtaining each value parameter based on calculation and achieving the antenna dimensions, the next step is to design the antenna in CST simulation. The CST studio suite is utilized to simulate a patch array microstrip antenna to measure the return loss (S11) and antenna gain.

In designing the patch array microstrip antenna, there are two critical part that needs to be consider and optimized. The first part is the distance between two array patches, which should be not less than $\lambda/2$ of the resonance frequency antenna. And then the next part is the T-Junction power divider, which will determine the impedance of both patch array.

5. CONCLUSION

A linear 1×2 "Ha (μm)"-slot patch array microstrip antenna is designed and simulated. The simulation's result shows that the patch array configuration can achieve return loss (S11) -25.363 dB with VSWR 1.1 at the frequency 2.4 GHz and the value for gain can reach 8.96 dBi. Hence, the result of the gain in patch array increased by 64.4 % if compared to the gain value of the single patch "Ha (μm)"-slot microstrip antenna.

6. CONFLICT OF INTEREST

The authors declare no conflict of interest.

7. REFERENCES

1. R.D.Tamas. Antenna and propagation: A sensor approach. *Sensors*, 21(4920):1–4 (2021). DOI: 10.3390/s21144920.

2. G. Ahmad, A. Sultan, M.I.K. Babar, M. Ashraf, and T. Jan. Fabrication and analysis of a triple band patch antenna. *Proceedings of the Pakistan Academy of Sciences A. Physical and Computational Sciences*, 55 (3): 45–51 (2018).
3. Najvia and S. Bashir. Broadband reflectarray antenna with high gain for X band (8 to 12GHz) applications. *Proceedings of the Pakistan Academy of Sciences: A. Physical and Computational Sciences*, 55(3), 21–33 (2018).
4. C.A. Balanis. *Antenna Theory: Analysis and Design*, 4th Edition. John Willey and Sons, New Jersey, USA (2016).
5. S. Gupta and T. Srivastava. A review on microstrip patch antenna and its miniaturisation techniques. *International Journal of Engineering and Technical Research*, 7(7): 81–84 (2017).
6. H. Yon, N. H. Abd Rahman, M. A. Aris, and H. Jumaat. Developed high gain microstrip antenna like microphone structure for 5G application. *International Journal of Electrical and Computer Engineering*, 10(3): 3086–3094 (2020), DOI: 10.21591/ijece.v10i3.pp3086-3094.
7. S. Sotyohadi, S.H. Pramono, and M. Sarosa. Design and fabrication of "Ha (μm)" shape-slot microstrip antenna for WLAN 2.4 GHz. *Proceedings of Second International Conference on Electrical Systems, Technology and Information 2015 (ICESTI 2015). Lecture Notes in Electrical Engineering*, 365: 383–391 (2016). DOI: 10.1007/978-981-287-988-2_41
8. M. Mynuddin and Md.Z. Rahman. Design and simulation of half wave-dipole antenna for LTE applications using CST microwave studio. *Journal of Electrical Engineering and Electronics Technology*, 9(4):1–4 (2020). DOI: 10.37532/jeet.2020.9(2)e.175.
9. M. Stanley, Y. Huang, H. Wang, H. Zhou, A. Alieldin, and S. Joseph. A capacitive coupled patch antenna array with high gain and wide coverage for 5G smartphone applications. *IEEE Access*, 6:1–13(2018). DOI: 10.1109/ACCESS.2018.2860795
10. V. Midasala, and P. Siddaiah. Microstrip patch antenna array design to improve better gains. *Procedia Computer Science*, 85:401–409 (2016).

- DOI: 10.1016/j.procs.2016.05.181.
11. D.I. Kaklamani, A. D. Panagapoulos, P.K. Gkonis. Antennas and propagation aspects for emerging wireless communication technologies. *Electronics* 10 (964):1–3 (2021). DOI:10.3390/electronics10080964.
 12. R.M. Sandoval, A.J. Garcia-Sanchez, F. Garcia-Sanchez, J. Garcia-Haro. Evaluating the more suitable ISM frequency band for IoT-based smart grids: A quantitative study of 915 MHz vs. 2400 MHz. *Sensors*, 17(76):1–15 (2017). DOI:10.3390/s17010076.
 13. B. Singh, N. Sarwade, K.P. Ray. A compact modified corporate feed network for antenna arrays with non-identical rectangular microstrip antenna elements. In: *2016 International Symposium on Antennas and Propagation (APSYM)*, Cochin, India. Institute of Electrical and Electronics Engineers. Curran Associates, Inc. USA, p. 17–20. (2016).
 14. U. Nissanov. THz equal and unequal 1 to 8 T-Junction power dividers. *Sensors International*, 2(100113):1–8 (2021). DOI: 10.1016/j.sintl.2021.100113
 15. Y.A. Rayisiwi, T. Hariyadi. Design of A 1:12 power divider at 5 GHz for ground surveillance radar application. *IOP Conf. Series: Materials Science and Engineering*, 384 (012053): 1–6 (2018). DOI: 10.1088/1757-899X/384/1/012053

Design and Simulation "Ha"-Slot Patch Array Microstrip Antenna for WLAN 2.4 GHz

ORIGINALITY REPORT

8%

SIMILARITY INDEX

8%

INTERNET SOURCES

2%

PUBLICATIONS

%

STUDENT PAPERS

PRIMARY SOURCES

1

www.icesti.org

Internet Source

6%

2

eprints.itn.ac.id

Internet Source

2%

Exclude quotes Off

Exclude bibliography Off

Exclude matches < 2%