

DETAIL TUTUP ATAS

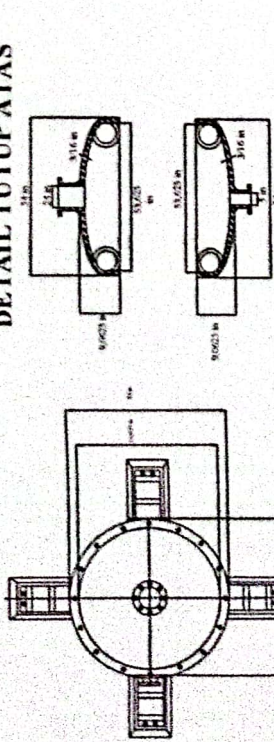

DETAIL TUTUP BAWAH



TAMPAK ATAS

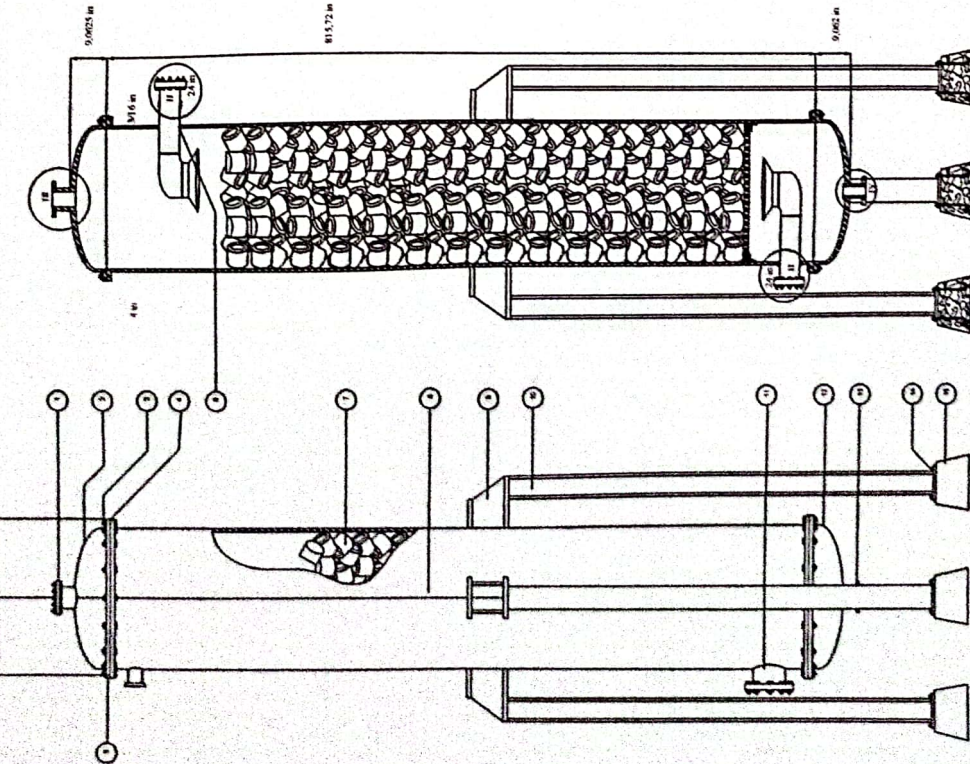

TAMPAK SAMPING

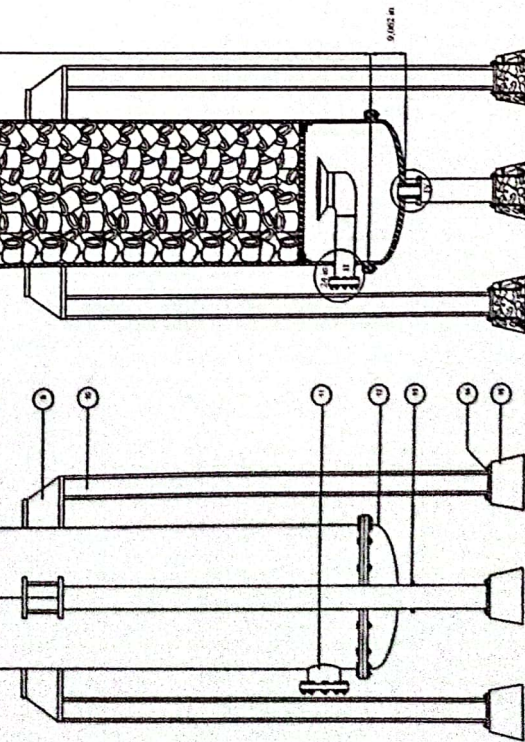

POTONGAN MEMBUJUR

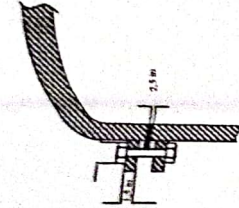
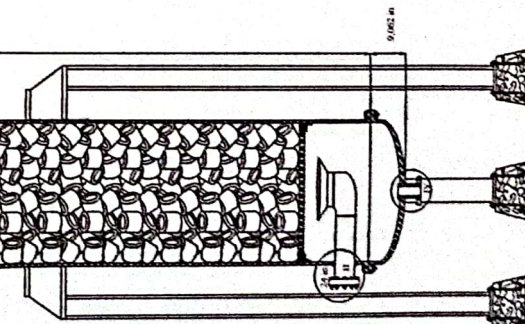

DETAIL FLANGE

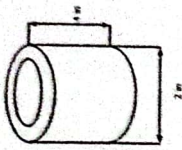

DETAIL PACKING (Reaching)

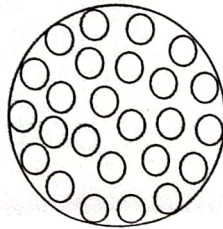

DETAIL SHOWER 25 LUBANG

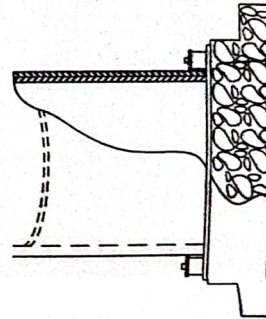
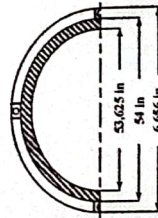

DETAIL SKIRT VESSEL

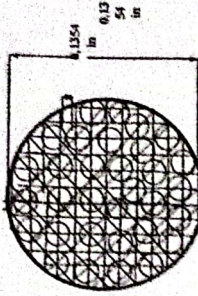

N₄ = 33 buah

DETAIL SPARGER

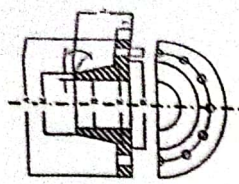

DETAIL NOZZLE

NOZZLE	NPS	A	T	E	L
1	1 1/2	5	11.16	2.78	2.716
2	1.8	2.5	1.916	2.1	1.916
3	1.4	2.1	1.38	1.6	1.38
4	1 1/2	5	11.16	2.78	2.716

NO	POSISI	RENCANA	SAHABAT	SAHABAT	SAHABAT
15	POKOK	CEMENT	SAHABAT	SAHABAT	SAHABAT
14	BASE PLATE	CARBON STEEL			
13	NOZZLE PENYALURAN LIQUID	HIGH ALLOY STEEL SA 240 GRADE M TYPE 304			
12	TUTUPAN GAS	HIGH ALLOY STEEL SA 240 GRADE M TYPE 304			
11	NOZZLE GAS MAUKUR	HIGH ALLOY STEEL SA 240 GRADE M TYPE 304			
10	PENYALUR	CARBON STEEL SA 240			
9	LID DAN GURSET	HIGH ALLOY STEEL SA 240 GRADE M TYPE 304			
8	KOLON ABSORBER	HIGH ALLOY STEEL SA 240 GRADE M TYPE 304			
7	PACKING	RENCANA			
6	NOZZLE LIQUID MAUKUR	HIGH ALLOY STEEL SA 240 GRADE M TYPE 304			
5	FLANSH	HIGH ALLOY STEEL SA 240 GRADE M TYPE 304			
4	GASRET	WELDED PLAT METAL			
3	BAUT	HIGH ALLOY STEEL SA 191 GRADE B A T TYPE 32			
2	TUTUPAN GAS	HIGH ALLOY STEEL SA 240 GRADE M TYPE 304			
1	NOZZLE GAS BUKAR	HIGH ALLOY STEEL SA 240 GRADE M TYPE 304			
0	KETERANGAN				

JURUSAN TEKNIK KIMIA
 FAKULTAS TEKNOLOGI INDUSTRI
 INSTITUT TEKNOLOGI NASIONAL MALANG

PERANCANGAN ALAT UTAMA
 KOLON ABSORBER

DIKORANGGUKAN
 2019/01/17

DOSEN PEMBIMBING

FAKULTAS TEKNOLOGI INDUSTRI
 INSTITUT TEKNOLOGI NASIONAL MALANG