



Potential Crude glycerol from Transesterification WCO (Waste Cooking Oil) as an anti-fungisida Spray

**Mohammad Istnaeny Hudha^{1*}, Elvianto Dwi Daryono¹,
Endah Kusuma Rastini¹**

¹Department of Chemical Engineering, Faculty of Industrial Technology,
Institute Technology of National Malang Bendungan Sigura-gura No. 2 Malang (65145)
Indonesia

Abstract : Waste cooking oil (WCO) can be used as an alternative raw material of biodiesel production with glycerol as a byproduct. Crude glycerol generated should be purified first. Glycerol purification process is done in two stages, namely saponification and acidification process. In the process of saponification strong alkali KOH is added to form the soap and then continued the acidification process with variation of pH 9.7; 9.6; 8.5; 4.7; 4.4 and the concentration of H₃PO₄ 65%, 75%, 85%. This purification process produces byproducts that K₂HPO₄ and KH₂PO₄ salt. Both the salt is being used as an anti-fungi spray (fungicide), particularly for powdery mildew on plants mango. In this study, the optimum concentration of phosphoric acid in the purification process of glycerol is 85% phosphoric acid concentration and pH optimum in the process of acidification on the purification of glycerol is pH 9.7 with K₂HPO₄ salts results and pH 4.7 with salt results KH₂PO₄. The melting point of each of the salt is 464 ° C and 252 ° C. As for the anti-fungi spray, K₂HPO₄ most effective in reducing the powdery mildew of mango plant with an efficiency of 13%.

Keywords : waste cooking oil, crude glycerol, saponification, acidification, anti-fungi spray.

Introduction

Waste cooking oil is the oil derived from oil frying foodstuff from several restaurants^{1,2}. Waste cooking oil has always been considered a waste by some communities. The number of exploration conducted to find alternative energy, making the used cooking oil starts to peep utilization. One is as a feedstock for biodiesel production^{3,4,5,6}. In the manufacture of biodiesel or waste cooking oil transesterification reaction byproducts generated in the form of glycerol with a low level of purity, which is commonly referred to as crude glycerol. The amount of glycerol produced as much as 10-15% of its production capacity with a purity level of glycerol ranges between 40-50% because they contain components of water and other impurities. In Indonesia, currently has a production capacity of biodiesel industry reached 4 million KL/year, it will produce crude glycerol around 400000-600000 tons/year. Increased production capacity biodiesel industry will lead to increased production of crude glycerol, so if it is not accompanied by advances in technology utilization and expansion of the market, the availability of excess glycerol will certainly make the price of glycerol in the world market into fall. Glycerol conversion into other products should be made to avoid any environmental concerns due to the waste glycerol, as well as improve the efficiency of the biodiesel industry². Anti-fungi spray them is one useful product obtained from the purification of crude glycerol.

Javani, A. (2012) conducted a study by varying the molar ratio of KOH to esters are 0.25, 0.5, 0.75, 1, 1.2, 1.4 and 1.6 as well as free fatty acid concentrations at 65% , 80%, 87%, 95.3%, 99.4% 99.51% and 99.58% in the production of high quality potassium phosphate through the purification step of glycerol, obtained purity potassium phosphate namely KH_2PO_4 and K_2HPO_4 with 98% purity and 98 , 05%. In his research using the acidification process with the addition of 85% phosphoric acid and pH in the acidification process 4.67 and 9.67.

Research Yildirm, Onogur E. & Irshad M. (2002) investigate about the efficacy of some of the natural chemicals against powdery mildew (*Uncinula Necator*) on vines that KH_2PO_4 has the effect of undermining the hyphae of fungi pathogens and depreciation conidia and conidiophores mold, mildew and penetrate cells disrupt the balance of potassium and cause rupture of walls of conidia. Additionally KH_2PO_4 could provide systemic resistance to fungi by forming insoluble compounds crystallize with Ca^{2+} in the cell healthy plants.

Research Azza M. Azmy K. (2014) regarding the control of powdery mildew on mango with some salt, biofungicide AQ10 growth regulator and fungicide compared with an exterminator in Egypt showed that K_2HPO_4 a salt more effective. This proves there is a reduction mango powdery mildew on plants by inhibiting the development of further damage to the mango and active in addressing the effects of the fungus. The results obtained are K_2HPO_4 efficiency of 82% and produced 82.1 kg of fruits/tree. Rapid absorption of phosphate by plant tissue and extreme mobility of phosphate in the network, as well as low cost, low toxicity to animals, the impact on the environment is safe and the nutritional value of phosphate, making phosphate as spraying the leaves are ideal for the control of plant diseases.

Based on the above, this study was developed to use crude glycerol from the transesterification WCO (Waste Cooking Oil) that will serve as an anti-fungi spray on plants of mango with variations in the concentration of phosphoric acid and pH in the acidification process.

Variations in the concentration of phosphoric acid in this study were taken from the concentration of phosphoric acid used in the main study Javani A. is 85%. Where in concentration 85%, Javani secured K_2HPO_4 and KH_2PO_4 salt crystals with high purity. From it, we want to find the optimum concentration of phosphoric acid with variation phosphoric acid concentration of 65%, 75% and 85% in the manufacture of anti-fungi spray material is the same as Javani of K_2HPO_4 and KH_2PO_4 salt crystals.

Variations in pH in the acidification process in this study were taken from the formation of salt crystals pH conditions K_2HPO_4 and KH_2PO_4 in major journals Javani A. and based on the data of each MSDS salt K_2HPO_4 and KH_2PO_4 . The main journal Javani A. using pH 9.67 and pH 4.67. While the data MSDS, K_2HPO_4 salt crystals formed in the pH range from 8.5 to 9.6 and KH_2PO_4 salt crystals formed in the range from 4.1 to 4.5. From it, we want to find the pH at optimum acidification process with the variation of pH 9.7, 9.6, 8.7, 4.7 and 4.4 in the manufacture of anti-fungi spray where the pH determines the best condition of the formation of salt crystals K_2HPO_4 and KH_2PO_4 using the acidification process.

Acidification processes (pickling) aims to outline the soap into acid glycerol fatty acid that will easily separate itself so it's easier to be purified. Parameters were made include the determination of the melting point and test% efficiency effectiveness of anti-fungai spray.

Experimental

Making Biodiesel and Crude Glycerol

- Filtering waste cooking oil with a filter paper and heated to over 110°C temperature to remove the water content of the waste cooking oil then cooled to a temperature of 60°C.
- Mixing methanol and 1% KOH catalyst of the mass of oil, then heated to 60 ° C, with a mole ratio of methanol and oil is 6: 1
- Mixing of waste cooking oil and a mixture of methanol-KOH in a three-neck flask, and refluxed with stirring speed of 500 rpm for 60 minutes to produce a crude methyl ester and glycerol (main product).

Saponification Process

- Considering crude glyserol as much as 50 ounces and was added to the glass batch reactor
- Adding KOH with a molar ratio of 1.6: 1 and mixed with stirring 500 rpm
- Keep mixing temperature at 25°C temperature and atmospheric pressure for 60 minutes and then obtained crude glyserol saponification results that will be used for the acidification process.

Acidification Process

- Preparing crude saponification glyserol results
- Adding a phosphoric acid with a certain concentration during mixing until the pH has been ditentukan
- Continue stirring for 15 minutes and then left until a precipitate is formed and then filtered with filter paper to obtain a powder potassium phosphate

Manufacture of crystalline potassium phosphate Anti Fungi

- Prepare a potassium phosphate deposition process results acidification and washed with IPA (Isoprophyl alcohol)
- Heating the mixture at a temperature 90°C for 60 minutes to remove the IPA and sediment will be crystallized
- Obtained crystals of potassium phosphate which is used as an anti-fungi spray..

Making anti-fungi spray

- Crystal K₂HPO₄ at pH acidification process and optimum concentration of phosphoric acid obtained was made in a concentration of 25 mM (435 g/100 liters of water)
- Crystal KH₂PO₄ at pH asdifikasi process and optimum concentration of phosphoric acid obtained was made in a concentration of 40 mM (544 g / 100 liters of water)
- Add Triton (B 1956) in each of K₂HPO₄ and KH₂PO₄ mixture of 25 mL / 100 liters of water
- Spray anti-fungi analyzed and tested

Testing Melting Point Crystals

1 g sample is inserted within the capillary, then compacting it by means menjatuh-drop the capillary. Putting a capillary tube at the heating part in deciding the melting point apparatus. Further decisive tool turned on the heater melting point. Then set the heating to set the temperature control knob coarse and fine temperature control. Then observe samples diselediki, then press the button display when the sample melts. Read the temperature or the melting point indicated on the tool. (Suleman, Nita, 2012)

Test% Effectiveness Efficiency Spray Anti-Fungi ⁷

Used a mixture of K₂HPO₄ and KH₂PO₄ mixture and spraying only water on a controlled variable. Spraying is applied at intervals of 2 days from watering plants

$$\% \text{ Efficiency} = \frac{\% \text{ infection control} - \% \text{ experimental infection}}{\% \text{ infection control}}$$

Equipment description

Making Biodiesel and Results Side *Crude Gliserol*

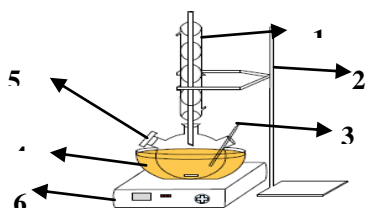

Explanation :	
1. Condenser	4. Container and heating medium
2. Support	5. Three neck flask
3. Termometer	6. Hot plate magnetic stirrer

Figure 1. Transesterification reactor

Proses Saponifikasi

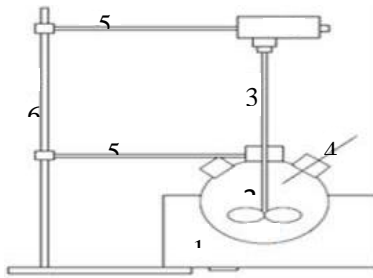

Explanation :	
1. Water bath	4. Termometer
2. Batch glass reactor	5. Clamp
3. Mixer	6. Support

Figure 2. Batch glass reactor

Asidification Process and production of crystalline potassium phosphate

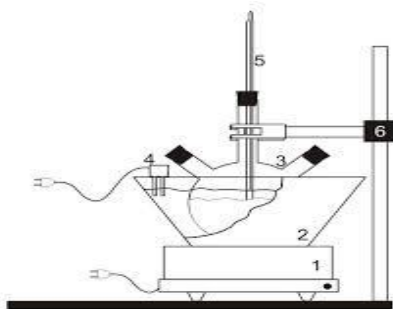

Explanation :	
1. Hotplate magnetic stirrer	4. Heater
2. Container and heating medium	5. Termometer
3. Three neck flask	6. Support

Figure 3. Acidification reactor

Result and Discussion

Results of analysis of crude glycerol in the manufacture of biodiesel from waste cooking oil

Table 1. Analysis results Crude Glicerol

Property	Value
pH	13,82
KOH	8,42 %
Soap (in K-linoleat)	19,23 %
Ash	17 %

pH tests show that glycerol byproduct of biodiesel used cooking oil having a pH of 13.82. The degree of acidity (pH) glycerol showed alkaline nature. This is due to the content of KOH and potassium soap. The content of KOH in glycerol derived from potassium base catalyst used in transesterikasi. The remaining catalyst along with other byproducts are glycerol. The content of potassium soaps derived from the saponification reaction of the ester and KOH.

Salt K_2HPO_4 and Salt KH_2PO_4

Phosphoric acid is a weak acid polyprotic (having three hydrogen atoms can be ionized). Ionization of hydrogen atoms in the phosphoric acid is shown in Figure 4. The salt of phosphoric acid and alkaline K can be formed by replacing one, two, or three H^+ ions with one, two, or three of K^+ ions to produce a salt KH_2PO_4 , K_2HPO_4 , or K_3PO_4 (image 5). In alkaline neutralization and soap solution K, a potassium salt formed from the neutralization reaction of alkaline and soap K with mineral acids as shown in Figure 5 and Figure 6.

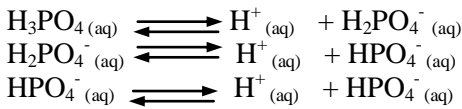

Figure 4. Ionization phosphoric acid

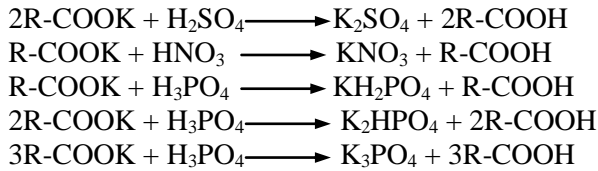

Figure 5. Reaksi Pemecahan Sabun

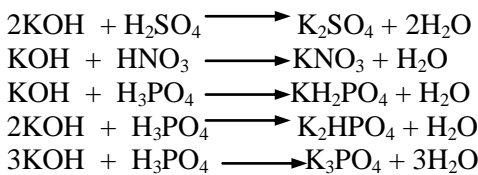

Figure 6. Alkaline neutralization reaction of potassium

Neutralization of alkaline and soap solution produces salt, water, and free fatty acids. Salt solubility in glycerol and methanol is very low. Many salt settles in a layer of glycerol. Water and residual methanol is more soluble in glycerol layer. Free fatty acids are not soluble in glycerol and form a separate layer on top of a layer of glycerol. Soap can cause the emulsion of glycerol and free fatty acids that are difficult to separate. The separation between the layers of glycerol and free fatty acids is complete after all the soap and the salt is broken down into free fatty acids. The use of KOH as base catalyst in the transesterification of triglycerides and methanol leaving the majority of bases potassium in glycerol. Residual base catalyst potassium contained in the glycerol byproduct of biodiesel transesterification of vegetable oil with potassium base catalyst is neutralized with a mineral acid into a potassium salt. This process is part of the purification of glycerol

Melting Point Test

The melting point of the test results in various concentrations of phosphoric acid and various pH acidification process obtained the following results.

Table 2. Test result of the melting point of Potassium Phosphate salts

No	Sample	Test Result
1	65% H ₃ PO ₄ pH 4,4	205°C
2	65% H ₃ PO ₄ pH 4,7	215°C
3	65% H ₃ PO ₄ pH 8,5	241°C
4	65% H ₃ PO ₄ pH 9,6	262°C
5	65% H ₃ PO ₄ pH 9,7	280°C
6	75% H ₃ PO ₄ pH 4,4	220°C
7	75% H ₃ PO ₄ pH 4,7	232°C
8	75% H ₃ PO ₄ pH 8,5	321°C
9	75% H ₃ PO ₄ pH 9,6	330°C
10	75% H ₃ PO ₄ pH 9,7	343°C
11	85% H ₃ PO ₄ pH 4,4	241°C
12	85% H ₃ PO ₄ pH 4,7	252°C
13	85% H ₃ PO ₄ pH 8,5	440°C
14	85% H ₃ PO ₄ pH 9,6	458°C
15	85% H ₃ PO ₄ pH 9,7	464°C

In Table 2 above shows that at different concentrations of phosphoric acid and pH changes in the acidification process affects the level of purity crystalline potassium phosphate salts. Potassium phosphate salts to be achieved in this research is the potassium salt monohydrogen phosphate (K_2HPO_4) and potassium dihydrogen phosphate (KH_2PO_4) purity salt approached with salt K_2HPO_4 and KH_2PO_4 truth. at $465^\circ C$ and $252,6^\circ C$. In the sample of 85% H_3PO_4 , approaching the melting point of the salt K_2HPO_4 and KH_2PO_4 ie on the sample 85% H_3PO_4 pH 9.7 and the sample 85% H_3PO_4 pH 4.7, respectively $464^\circ C$ and $252^\circ C$. Thus, the samples at concentration of 85% H_3PO_4 salt formed K_2HPO_4 pH 9.7 and at 85% H_3PO_4 pH 4.7 KH_2PO_4 salt formed. While the overall sample concentration of 65% H_3PO_4 and 75% H_3PO_4 only salt formed KH_2PO_4 . This is because the melting point of the whole sample is closer to the melting point of salt KH_2PO_4 than the melting point of salt K_2HPO_4 . Of the three types of the concentration of phosphoric acid obtained optimum concentration of phosphoric acid at a concentration of 85%. This is due to the high acid levels will be better because the acidification process emulsion soap into fatty acids and salts getting bigger. So that the purity of the salt obtained even greater. Based on table 4.2, that the salt K_2HPO_4 pH more alkaline than KH_2PO_4 salt is above 7. In a sample concentration of 85% H_3PO_4 salt formed K_2HPO_4 pH 9.7 and the sample 85% H_3PO_4 pH 4.7 KH_2PO_4 salt formed. In each of the pH with H_3PO_4 concentration of 85% obtained second level of purity salt is very high, almost the same / approaching the melting point of the actual salt.

Test% Effectiveness Efficiency Spray anti-fungi

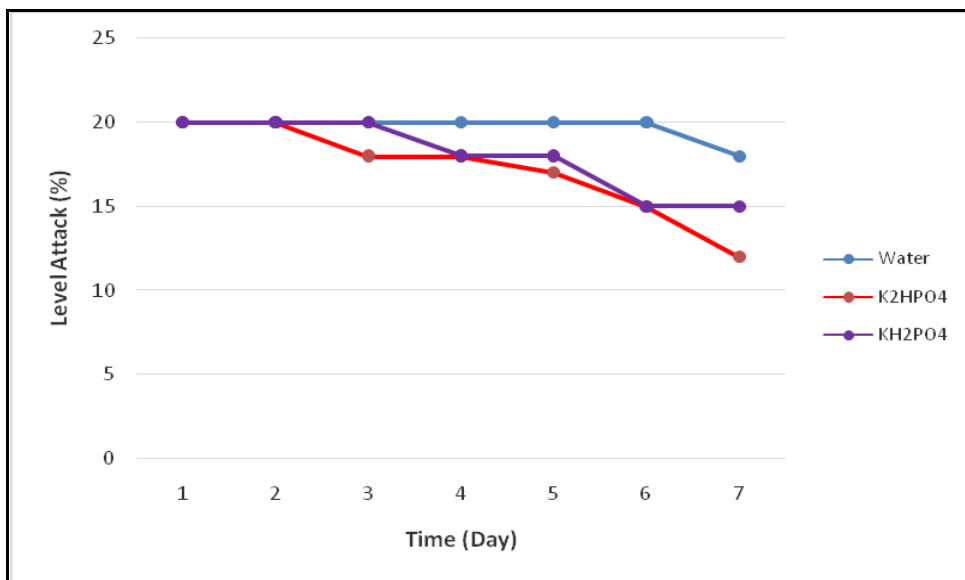

Figure 7. The relationship between the spraying time and the attack level

Based on Figure 7, the level of fungi attack on the leaves of mango tested with three materials sprayers are spraying only water as the controlled variable (without material fungicide), sprayers K_2HPO_4 (plus triton B-1956) as well as spraying KH_2PO_4 (plus triton B-1956). The leaves were tested amounted to 9 leaves of mango plant. On the first day until the seventh day obtained fungi attack rate decreases with each increment difference in the materials used. On the use of materials such as water (controlled variable without fungicide mixture) obtained degree of fungi attack first day to the sixth is still the same, there is no reduction in the level of attack, on the seventh day began to decrease 18% rate of fungi attack.

In the use of materials such K_2HPO_4 fungi attack level obtained third day began to decrease by 18%, the next level is reduced fungi attack added a lot on the fifth, sixth and seventh, respectively 17%, 15% and 12% levels of fungi attack. In the use of materials such fungi attack level obtained KH_2PO_4 fourth day began to decrease by 18%, the next level is reduced fungi attack added a lot on the sixth day and remained constant until the seventh day, respectively by 15% the level of fungi attack. Thus, the results of which are shown during the 7 days of spraying the material tested third level obtained fungi attack the mango crop is reduced more rapidly by spraying material K_2HPO_4 compared with that of KH_2PO_4 and water.

Conclusion

- The optimum concentration of phosphoric acid in the purification process of glycerol is 85% phosphoric acid concentration and pH optimum in the process of acidification on the purification of glycerol is pH 9.7 with K_2HPO_4 salts results and pH 4.7 with salt results KH_2PO_4 .
- The melting point of each of the salt is 464 ° C and 252 ° C, approaching the melting point of salt K_2HPO_4 and KH_2PO_4 actual
- Spray antifungi K_2HPO_4 more effectively reduce powdery mildew on the leaves of mango by 13%

References

1. Zaher Z., Gad M.S. Assesment of Biodiesel Derived from Waste Cooking Oil as an Alternative Fuel for Diesel Engines. International Journal of Chem Tech Research, 2016, 9(3) : 140-146
2. Maheswari A., Tamilmagan, Bijesh P., Gopal A. Bioediesel Production from Waste Cooking Oil Using Green Synthesized nano Fe_2O_3 and CuO Impregnated nano Fe_3O_4 . International Journal of Chem Tech Research. 2015, 8(5) :90-96
3. Rajagopal, K. Johnson J., Rajadurai J., Production of Biodiesel from Waste used Cooking Oil using two Different Alkaline Catalysts. International Journal of Chem Tech Research. 2015, 8(2) : 754-759
4. M. C. Math, I S Prem Kumar, S V Chetty, Technologies for biodiesel Production from Used Cooking Oil – A review, Energy for sustainable Development. 2010, 5. 334-345.
5. Sathish S. Shankar A. Choudhury A P. Optimization of Process Parameters to Enhances the Yield of Biodiesel by Using Heterogeneous Catalyst. 2016, 9(07). 334-339
6. Ahmed F. Giwa S O. Ibrahim M. Giwa A. Production of Biodiesel from Jatropha Curcas Seed Oil using Base Catalysed Transesterification. 2016, 9(06). 322-332
7. Azza M. K. Azmy. “Controlling Of Mango Powdery Mildew By Some Salts, Growth Regulators and The Biofungicide AQ10 Compared With Punch Fungicide in Egypt”. American Journal Of Life Sciences. 2014. ISSN:2328-5702
8. Edward A. Baker, Ann L. Hayes and Ruth C. Butler. Physico-chemical Properties Of Spray Solutions and Their Impact On Penetration, 1992, 34, 27-41
9. Gottstein, H.D., and Kuc, J. “Induction of Systemic Resistance to Anthracnose in Cucumber by Phosphates”, Phytopathology, 1989, 79, 176-179
10. Hajek, martin et al. Purification Of The Glycerol Phase After Transesterification Of Vegetable Oils. International Petroleum Conference, Bratislava, Slovak Republic, 2009.
11. J. Schonherr, Foliar Nutrition Using Inorganic Salts: Laws Of Cuticular Penetration, German: Instiut Of Vegetable and Fruit Science Division, University Of Hannover, 2002.
12. Javani, A. Hasheminejad, M. Tahvildari, K & Tabatabaei, M., High Quality Potasium Phosphate Production Through Step-By-Step Glycerol Purification: A Strategy to Economize Biodiesel Production, Bioresource Technology 2012, 104, 788-790, Departement Of Applied Chemistry, Faculty Of Chemistry, Islamic Azad University, Tehran North Branch, 191367-4711 Tehran, Iran
13. Salem A. Elshatshat. (2004). “Effects Of Inorganic Salts On Water Permeability Of Isolated Cuticular Membranes”, Bonn: Rheinischen Friedrich-Wilhelms-Universitat Bonn
14. Sigma-Aldrich Co. LLC. 2015. “MSDS Potassium Phosphate dibasic ACS reagent $\geq 98,0\%$ ” , P3786 Sigma-Aldrich
15. Sigma-Aldrich Co. LLC. 2015. “MSDS Potassium Phosphate Monobasic ACS reagent $\geq 99,0\%$ ” , P0662 Sigma-Aldrich
16. Yildirim, E. Onogur and M. Irshad. (2002). “Investigations On The Efficacy Of Some Natural Chemicals Against Powdery Mildeew (*Uncinula necator*) Of Grape”. ISSN 0931-1785
