

Optimal placement of FACTS controllers for maximising system loadability by PSO

by I Made Wartana

Submission date: 16-Aug-2019 10:46AM (UTC+0700)

Submission ID: 1160521871

File name: f_FACTS_controllers_for_maximising_system_loadability_by_PSO.pdf (836.32K)

Word count: 8564

Character count: 43048

Optimal placement of FACTS controllers for maximising system loadability by PSO

I. Made Wartana, Jai Govind Singh*,
Weerakorn Ongsakul and
Sasidharan Sreedharan

Energy Field of Study,
School of Environment Resources and Development,
Asian Institute of Technology,
Bangkok 12120, Thailand
E-mail: i.made.wartana@ait.asia
E-mail: jgsingh@ait.asia
E-mail: ongsakul@ait.asia
E-mail: sasiait@gmail.com
*Corresponding author

Abstract: In this paper, a multi objective-based method has been suggested to enhance the power system loadability with optimal placement of flexible AC transmission system (FACTS) controllers using particle swarm optimisation (PSO) technique. The objective function is to maximise the system loadability subjected to maintaining the system security, integrity, and stability margins within limits by obtaining the optimal location, installation costs, and control settings of the FACTS controllers. The various FACTS controllers, i.e., static var compensator (SVC), thyristor controlled series compensator (TCSC), and unified power flow controller (UPFC), have been considered in this study. The effectiveness of the proposed methodology has been investigated on the standard IEEE 14-bus, 30-bus, and practical Java-Bali 24-bus Indonesian system and the results are compared with the method suggested in the literatures. Moreover, the results obtained by PSO have also been compared with other evolutionary approach, viz., genetic algorithm (GA).

Keywords: maximum system loadability; particle swarm optimisation; PSO; genetic algorithm; GA; system security; stability margins; thyristor controlled series compensator; TCSC; static var compensator; SVC; unified power flow controller; UPFC; energy conversion.

Reference to this paper should be made as follows: Wartana, I.M., Singh, J.G., Ongsakul, W. and Sreedharan, S. (2013) 'Optimal placement of FACTS controllers for maximising system loadability by PSO', *Int. J. Power and Energy Conversion*, Vol. 4, No. 1, pp.9–33.

Biographical notes: I. Made Wartana received his BEng and MEng from Electrical Engineering Department, National Institute of Technology (ITN) Malang, East of Java, Indonesia and Bandung Institute of Technology (ITB), Indonesia in 1986 and 1994, respectively. He has been an Assistant Professor at ITN Malang, Indonesia since 1994. He is currently pursuing his Doctoral degree at the Asian Institute of Technology, Thailand. His research interests are in application of FACTS controllers in power grid, AI application to power system, and in grid integration of renewable.

Jai Govind Singh received his MTech and PhD from IIT Rookree, and IIT Kanpur India, all in Electrical Engineering, in 2003 and 2008, respectively. He is currently an Assistant Professor in the energy field of study, Asian Institute of Technology, Thailand. His research interests include power system operation and control, FACTS, power sector deregulation and power system planning, integration of renewable energy resources into power system and power distribution system.

Weerakorn Ongsakul received his MS and PhD in Electrical Engineering from Texas A&M University, College Station, USA in 1991 and 1994, respectively. He is currently an Associate Professor and Dean of School of Environment, Resources and Development, Asian Institute of Technology, Thailand. His current interests are in parallel processing applications, AI applications to power systems, and power system restructuring and deregulation.

Sasidharan Sreedharan received his BTech in Electrical and Electronics and MTech in Electrical Power Systems from Government Engineering Thrissur, Kerala, India in 1995 and 1998, respectively. He received his Doctoral degree from the Asian Institute of Technology, Bangkok. His research interests are in grid integration of renewable, AI applications to power systems and grid stability.

1 Introduction

Over the last few years, the practices and traditional concepts of power networks have been changing due to the modernisation as well as deregulation of the electricity market. It has become imperative to better utilise the existing power networks to increase capacity by installing flexible AC transmission system (FACTS) controllers (Hingorani, 2000). The variables and parameter of the transmission line, which include line reactance, voltage magnitude, and phase angle are able to be controlled using FACTS controllers in a fast and effective way (Po, 2000). The benefits derived from FACTS include improvement of the stability of power system networks, such as the small signal stability, transient stability, and reactive power support and thus, enhance system reliability. However, controlling power flows is the main function of FACTS controllers (Hingorani and Gyugyi, 2000). Maximal system loadability (SL) can also be obtained with the optimal location and parameter setting of FACTS controllers (Kumar et al., 2005; Behshad et al., 2009). These basic ideas behind the FACTS concept play an active role in the operation and control of competitive power systems.

The maximum benefit of the FACTS controllers depends greatly on how these controllers are allocated in the power system, namely, on their location and setting (Benabid et al., 2009). The range of FACTS controllers are very wide and depend on application type. A few are given here and included in this study:

- static var compensator (SVC)
- static compensator (STATCOM)
- thyristor controlled series compensator (TCSC)

- static synchronous series compensator (SSSC)
- unified power flow controller (UPFC).

In the last decade, in the research arena of computational intelligence, several cooperative and competitive stochastic search techniques have rapidly gained popularity as efficient optimisation techniques. Such techniques include a hybrid Tabu Search (TS) and simulated annealing (SA) (Bhasaputra and Ongsakul, 2003), evolutionary programming (EP) (Jirapong and Ongsakul, 2007), genetic algorithm (GA) (Cai et al., 2004; Rashed et al., 2007), bacterial swarming algorithm (BSA) (Lu et al., 2008), and particle swarm optimisation (PSO) (Saravanan et al., 2007; Shaheen et al., 2007). PSO is a relatively recent heuristic optimisation technique developed by Kennedy and Eberhart (1992). This robust stochastic optimisation technique is based on the movement and intelligence of swarms. When compared with mathematical algorithm and other heuristic optimisation techniques (Benabid et al., 2009), its main advantages are summarised as simple concept, easy implementation, robustness to control parameters, and computational efficiency. However, these superior characteristics make PSO highly viable to be also used for solving multi-objective optimisation problems (Benabid et al., 2009; Li, 2003; Abido, 2006).

Much research has been focused on the optimal placement of FACTS controllers. Using multi-type FACTS controller with TS and SA was proposed in Bhasaputra and Ongsakul (2003) to minimise generator fuel costs in optimal power flow control. GA has been attempted to find the optimal location of different types of FACTS controllers in the power network in order to increase loadability of the system and to minimise generation costs and investment costs on the controllers (Cai et al., 2004). Optimal allocation of FACTS controllers to maximise system loadability (MSL) in system security margins and to minimise the total generation fuel cost was found using BSA (Lu et al., 2008). GA and PSO techniques have been formulated to solve optimal location and parameter settings of multiple TCSCs to increase power SL. The application of PSO technique for optimal location of multiple FACTS controllers, taking into consideration the cost of installation and the SL, has been reported (Rashed et al., 2007; Saravanan et al., 2007; Shaheen et al., 2007). However, maximising SL by minimising the investment costs of FACTS and their impact on system security and stability margins using PSO algorithm have not yet been explicitly considered.

In this paper, the PSO algorithm is developed for optimal placement of different types of FACTS controllers to MSL while maintaining system security and stability margins within limits. By means of the optimal placement of FACTS controllers, SL is maximised and simultaneously the installation cost of FACTS controllers is also minimised. To realise the proposed objective, three types of FACTS controllers, namely TCSC, SVC, and UPFC, their location and their parameter settings must be determined.

This paper is organised into six sections, beginning with an introduction, followed by Section 2 which presents the modelling of TCSC, SVC, and UPFC. The problem formulation is proposed in Section 3 which includes the definition of objective functions and problem constraints. Section 4 presents the implementation of the PSO algorithm. Some interesting results are presented along with a detailed discussion in Section 6. Finally, conclusions and major contributions are summarised in Section 7.

2 Static modelling of FACTS controllers

2.1 Model of TCSC

The basic idea behind power flow control with the TCSC is to decrease or increase the overall lines effective series transmission impedance, by adding a capacitive or inductive reactive, respectively. The TCSC (Hingorani and Gyugyi, 2000) is modelled as variable impedance where the equivalent reactance of line, connected between bus- i and bus- j , is defined as:

$$X_{ij} = X_{line} + X_{TCSC} \quad (1)$$

where X_{line} is the original transmission line reactance, and X_{TCSC} is the TCSC reactance. After installing TCSC, the new reactance of line is presented by:

$$X_{ij} = (1 - c_p) X_{line} \quad (2)$$

where c_p is the percentage of reactance compensation. The level of the applied compensation of the TCSC usually varies between 20% inductive and 80% capacitive (Gerbex et al., 2001).

2.2 Model of SVC

The SVC is defined as a shunt compensator and its output is adjusted to exchange capacitive or inductive reactance in order to maintain or control specific parameters of an electrical power system, typically a bus voltage (Hingorani, 1993). In this paper, the SVC is modelled by the algebraic equation expressing the reactive power injected at the bus- i in this work:

$$\left. \begin{aligned} Q_i &= b_{SVC} V_i^2 \\ b_{SVC}^{\min} &\leq b_{SVC} \leq b_{SVC}^{\max} \end{aligned} \right\} \quad (3)$$

2.3 Model of UPFC

The UPFC has two voltage source inverters (VSI) sharing a common dc link capacitor. It is connected to the system through two coupling transformers (Milano, 2005) as shown in Figure 1. The UPFC (Gyugyi, 1992) model is represented by one series voltage source v_s and by another shunt current source i_{SH} . In this work, UPFC has been assumed to be placed at bus- i and in line connected between bus- i and bus- j . The series voltage source and the shunt current source of UPFC are defined as follows:

$$\left. \begin{aligned} \bar{v}_s &= (v_p + v_q) e^{j\varphi} = r \bar{V}_i e^{j\gamma} \\ \bar{i}_{SH} &= (i_p + i_q) e^{j\theta_i} \end{aligned} \right\} \quad (4)$$

The equations of the apparent power injected by the UPFC at bus- i and bus- j , while placed at bus- i , are $P_{iju} + jQ_{iju}$ and $P_{jiu} + jQ_{jiu}$, respectively, and given as follow.

$$\left. \begin{aligned} P_{iju} &= brV_iV_j \sin(\gamma + \theta_i - \theta_j) \\ Q_{iju} &= brV_i^2 \cos \gamma - i_q V_i \\ P_{jiu} &= -brV_iV_j \sin(\gamma + \theta_i - \theta_j) \\ Q_{jiu} &= -brV_iV_j \cos(\gamma + \theta_i - \theta_j) \end{aligned} \right\} \quad (5)$$

Figure 1 Model of UPFC (see online version for colours)

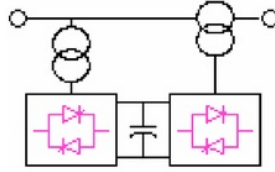

3 Problem formulation

In this paper, the aim of optimisation is to place the FACTS controllers in power network at the most suitable positions in order to get maximum benefits by finding the optimal location and setting of different types of FACTS controllers. The objective is to MSL by maintaining security and stability margins within limits and minimising the investment cost (C) of the FACTS controllers to be installed. The objective functions taken into account in this paper are expounded in detail in following section.

3.1 MSL by maintaining security and stability margins

$$\text{Maximise } F_1(\mathbf{x}, \mathbf{u}) = \{\lambda_1\} \quad (6)$$

$$\text{Subject to } VL = \sum_{i=1}^{N_l} OLL_i \times \sum_{j=1}^{N_b} BVV_j \quad (7)$$

where VL is the thermal and bus violation limit factor, OLL_i and BVV_j represent the overloaded line factor of branch and the bus voltage violation factor, respectively; and are elaborated in (11) and (12); N_l and N_b are the [20] numbers of transmission lines and buses, respectively, in the system. In addition λ_1 is a load parameter of the system, which intends to locate the maximum sum of power that the network is able to supply within the system security margin.

The load parameter λ_1 in (6) is defined as a function of a load factor λ_f

$$\lambda_1 = \exp\left[\gamma \left| \lambda_f - \lambda_f^{\max} \right| \right] \quad \lambda_f \in [1, \lambda_f^{\max}] \quad (8)$$

where γ is the coefficient to adjust the slope of the function, and λ_f^{\max} is the maximal limit of λ_f . The loading factor λ_f reflects the variation of power loads P_i and Q_i , which are defined in Lu et al. (2008) and as follow:

$$P_i(\lambda_f) = \lambda_f P_i \quad i = m+1, \dots, N_b \quad (9)$$

$$Q_i(\lambda_f) = \lambda_f Q_i \quad i = m+1, \dots, N_b \quad (10)$$

where m is the total number of generator buses. $\lambda_f = 1$ indicates the base case load.

The indexes of the system security state consist of two parts. The first part, OLL_i , relates to the branch loading and penalises overloads in the line. The value of OLL_i equals to 1 if the j^{th} branch loading is less than its rating. OLL_i increases logarithmly (actual logarithm) with the overload and it can be calculated from:

$$OLL_i = \begin{cases} 1; & \text{if } P_{ij} \leq P_{ij}^{\max}, \\ \exp\left(\Gamma_{OLL} \left| 1 - \frac{P_{ij}}{P_{ij}^{\max}} \right| \right); & \text{if } P_{ij} \geq P_{ij}^{\max}, \end{cases} \quad (11)$$

where P_{ij} and P_{ij}^{\max} are the real power flow between buses- i and j and the thermal limit for the line between buses- i and j , respectively. Γ_{OLL} is the coefficient which is used to adjust the slope of the exponential function.

The second part BVV_j in (7) concerns the voltage levels for each bus of the power network. The value of BVV_j is defined as:

$$BVV_j = \begin{cases} 1; & \text{if } 0.9 \leq V_b \leq 1.1 \\ \exp(\Gamma_{BVT} |1 - V_b|); & \text{otherwise} \end{cases} \quad (12)$$

here BVV_j is the bus voltage violation factor at bus- j and Γ_{BVT} represents the coefficient used to adjust the slope of the exponential function in the above equation. The equation shows that appropriate voltage magnitudes are close to 1 pu. Similar to OLL_b , the value of BVV_j is equal to 1 if the voltage level falls between the minimal and maximal voltage limits. Outside the range, BVV_j increases exponentially with the voltage variation.

3.2 The installation cost function of FACTS controllers

The installation cost of FACTS controllers has been mathematically formulated and is given by (Rashed et al., 2007; Saravanan et al., 2007).

$$F_2(\mathbf{x}, \mathbf{u}) = C(f) \times S \times 1,000 \quad (13)$$

where $F_2(\mathbf{x}, \mathbf{u})$ is the optimal installation cost of FACTS controllers in USS, $C(f)$ is the installation cost of FACTS controllers in USS/kVAR and f is vector that represents the control variable of FACTS controllers.

Based on the Siemens AG Database (Cai et al., 2004; Saravanan et al., 2007), the cost functions for SVC, TCSC, and UPFC have been used in this study. The cost functions considered in this work for various FACTS controllers are as follow.

$$\text{For SVC: } C_{SVC} = 0.003S^2 - 0.3051S + 127.38 \quad (14)$$

$$\text{For TCSC: } C_{TCSC} = 0.0015S^2 - 0.7130S + 153.75 \quad (15)$$

For UPFC: $C_{UPFC} = 0.0003S^2 - 0.2691S + 188.22$ (16)

where C_{TCSC} , C_{SVC} , and C_{UPFC} are in US\$/kVAr and S is the operating range of the FACTS controllers in MVar.

$S = |Q_2| - |Q_1|$ (17)

where Q_2 is the reactive power flow in the line after installing FACTS controllers in MVar and Q_1 is the reactive power flow in the line before installing FACTS controllers in MVar. The cost function for TCSC, SVC, and UPFC are shown in Figure 2.

Figure 2 Installation cost function of the FACTS controllers (see online version for colours)

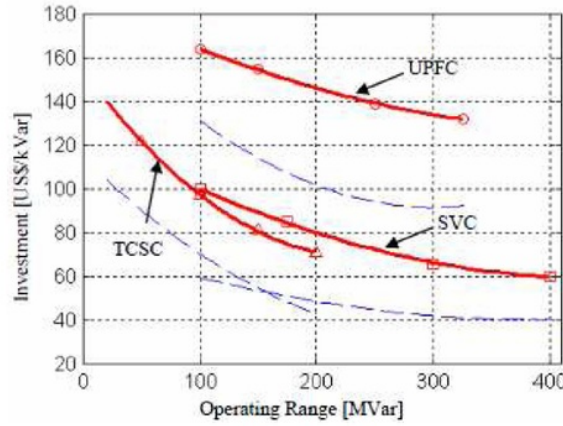

3.3 Dependent and control variables

In the two objective functions viz., (6) and (13), \mathbf{x} is the vector of dependent variables such as slack bus power P_{G_1} , load bus voltage $V_{m+1} \dots V_{N_b}$, generator reactive power outputs Q_G and apparent power flow S_k ; \mathbf{x} can be expressed as:

$\mathbf{x}^T = [P_{G_1}, V_{m+1} \dots V_{N_b}, Q_{G_1} \dots P_{G_m}, S_1 \dots S_{N_l}]$ (18)

Furthermore, \mathbf{u} is a set of the control variables, such as generator real power outputs P_G except at the slack bus P_{G_1} , generator voltages V_{G_i} , and the locations of FACTS controllers, L , and their parameter settings and \mathbf{u} can be expressed as:

$\mathbf{u}^T = [P_{G_2} \dots P_{G_m}, V_{G_1} \dots V_{G_m}, L, X_{TCSC}, b_{SVC}, v_s, i_{SH}, \lambda_f]$ (19)

The equality and inequality constraints of the Newton Raphson power flow (NRPF) problem incorporating FACTS controllers are given in following subsection.

3.4 Equality constraints

These constraints represent the typical load flow equations as follows:

$$P_{G_i} = P_{L_i} + V_i \sum_{j=1}^{N_b} V_j (G_{ij} \cos \delta_{ij} + B_{ij} \sin \delta_{ij}); \quad i = 1, 2, 3 \dots N_b \quad (20)$$

$$Q_{G_i} = Q_{L_i} + V_i \sum_{j=1}^{N_b} V_j (G_{ij} \sin \delta_{ij} - B_{ij} \cos \delta_{ij}); \quad i = 1, 2, 3 \dots N_b \quad (21)$$

where N_b is the number of buses in the system.

3.5 Inequality constraints

Inequality constraints $h(\mathbf{x}, \mathbf{u})$ are limits of control variables and state variables. Generator active power P_G , reactive power Q_G , voltage V_i , and phase angle δ_i are restricted by their limits as follows:

$$\left. \begin{aligned} P_{G_i}^{\min} &\leq P_{G_i} \leq P_{G_i}^{\max} & i = 1, \dots, m \\ Q_{G_i}^{\min} &\leq Q_{G_i} \leq Q_{G_i}^{\max} & i = 1, \dots, m \\ V_i^{\min} &\leq V_i \leq V_i^{\max} & i = 1, \dots, N_b \\ -0.9 &\leq \delta_i \leq 0.9 & i = 1, \dots, N_b \end{aligned} \right\} \quad (22)$$

The parameter settings of different types of FACTS controllers are restricted by their limits as follows:

$$\left. \begin{aligned} X_{TCSC}^{\min} &\leq X_{TCSC} \leq X_{TCSC}^{\max} \\ b_{SVC}^{\min} &\leq b_{SVC} \leq b_{SVC}^{\max} \\ v_S^{\min} &\leq v_S \leq v_S^{\max} \\ i_{SH}^{\min} &\leq i_{SH} \leq i_{SH}^{\max} \end{aligned} \right\} \quad (23)$$

The constraint of transmission loading P_{ij} is represented as:

$$|P_{ij}| \leq P_{ij}^{\max}; \quad ij = 1, \dots, N_l \quad (24)$$

The load factor λ_f is constrained by its limits as:

$$1 \leq \lambda_f \leq \lambda_f^{\max} \quad (25)$$

3.6 Power system stability constraints

a Power system stability

Every generator has an arrangement of non-linear differential equations relating to the synchronous machine, exciter, and any other control mechanisms. Every generator also has a series of algebraic equations, which link the generator state

variables and the generator's steady state operating point power injection into the system. Last, are the power system network equations; namely, Kirchhoff's law circuit equations, that the steady-state operating point must satisfy. The small signal stability model of the system can be expressed as $\Delta\dot{x} = A\Delta x$ where A is the system state matrix (Kumar et al., 2005; Milano, 2005),

$$A = F_x - F_y G_y^{-1} G_x \quad (26)$$

where F_x, F_y, G_y, G_x are power flow Jacobian matrices.

If the complex eigenvalues of the linearised system have negative real parts, then the power system could be able to withstand small disturbances and is thus, considered stable in the small-signal sense. The eigenvalue stability analysis is incorporated in the constraint by the equation

$$E_i(F_x, F_y, G_y, G_x) = 0 \quad (27)$$

The eigenvalue-based stability assures grid stability under various levels of SL.

b Fast voltage stability index

Fast voltage stability index ($FVSI$) proposed by Musirin and Rahman (2002) is utilised in this paper to assure the safe bus loading.

$$FVSI_{ij} = \frac{4Z^2 Q_j}{V_i^2 X} \quad (28)$$

The line that exhibits $FVSI$ close to 1.00 implies that it is approaching its instability point. If $FVSI$ goes beyond 1.00, one of the buses connected to the line will experience a sudden voltage drop leading to the collapse of the system. $FVSI$ index incorporation in the controller assures that no bus will collapse due to overloading.

c Line stability factor

System stability index is also assured by line stability factor (LQP) proposed by Suganyadevia and Babulal (2009). The LQP should be less than 1.00 to maintain a stable system.

$$LQP = 4 \left(\frac{X}{V_i^2} \right) \left(\frac{X}{V_i^2} P_i^2 + Q_j \right) \quad (29)$$

L_{mn} and LQP assure the controller that no line is over loaded under any grid condition.

4 PSO implementation

4.1 Overview of PSO

PSO is a relatively new and robust stochastic heuristic optimisation technique introduced by Kennedy and Eberhart (1995). It is based on the movement and intelligence of swarms

of insects or flocks of birds and other such group²⁸ in a PSO system, the group is a community made up of all flying particles moving around in a multidimensional space. While in flight, each particle modifies its position according to its own experience, as well as the experience of neighbouring particles, until it finds a relatively static point or until²¹ computational limitations are surpassed.

Each particle in search space is defined by the following elements (Birge, 2003; d²¹Valle et al., 2008): x_i^k is the value of particle i at generation k . The update of particle i in the search space is defined by (31); P_{best_i} is the best value found by the particle i until generation k ; v_i^{k+1} is the velocity of particle i at generation k . The update of velocity during the search procedure is presented by (31); g_{best} is the best particle found in the group until generation k .

$$x_i^{k+1} = x_i^k + v_i^{k+1} \quad (30)$$

$$v_i^{k+1} = \omega \times v_i^k + c_1 \times rand_1 \times (p_{best_i} - x_i^k) + c_2 \times rand_2 \times (g_{best} - x_i^k) \quad (31)$$

where

ω weighting function

c_j weighting factor

$rand_i$ random number between 0 and 1

P_{best_i} p_{best} of particle i

g_{best} g_{best} of the group.

The following weighting function is usually utilised (Benabid et al., 2009):

$$\omega = \omega_{max} - \frac{\omega_{max} - \omega_{min}}{iter_{max}} \times iter \quad (32)$$

where

ω_{max} initial weight

ω_{min} final weight

$iter_{max}$ maximum iteration number

$iter$ current iteration number.

4.2 Calculation of fitness function

The controlled problem of optimisation for the best possible placement of single and multi-type FACTS controllers is changed into an unconstrained optimisation problem using a penalty factor (PF) as given in (33). This becomes the fitness function in the PSO technique.

$$\text{Fitness function} = \mu_1 F_1 - \mu_2 F_2 + PF \times |VL - 1| \quad (33)$$

There are three terms in the above equation (33). The first term corresponds to MSL of FACTS controllers as formulated in (6). The second term corresponds to minimisation of the installation costs of FACTS controllers represented by (13) and the last term corresponds to a constraint violation that is multiplied by a PF to calculate the fitness function given in (33) for each particle. μ_i is the weighting coefficient which is used to adjust the slope of the PSO. For each particle, the line data is updated according to its TCSC's or UPFC's setting and location and the bus data is updated according to its SVC's or UPFC's setting, location and the current SL. The NRPF method is performed to gauge the voltage at each bus and line flow. Using these results, the value of VL for each particle is attained by using (7) and the fitness function of each particle is calculated by using (33). The particle that gives the maximum value for the fitness function in the population is considered as g_{best} particle.

The new velocity and the new position of each particle are calculated using (31) and (30), respectively. The procedures are repeated until the maximum number of iterations is reached then the value of VL for the g_{best} particle is checked. If the value is equal to 1, then using that g_{best} particle, the current value of SL can be met out without violating line flow and bus voltage limit constraints. In addition, the g_{best} particle is saved together with its installation cost and SL. SL is then increased again when the PSO algorithm is run. If the value of VL for the g_{best} particle is not equal to 1 then the g_{best} particle is unable to meet out the current SL and the g_{best} particle with $VL = 1$, obtained in the previous run, is considered as the best optimal setting. The SL corresponding to that g_{best} particle is considered as the MSL.

5 Genetic algorithm

5.1 Overview of GA

GA is one kind of stochastic search techniques based on the mechanism of natural selection and survival of the fittest (Cai et al., 2004; Rashed et al., 2007). Furthermore, it combines the evaluation function with a random exchange and/or well-structured information between solutions to arrive at a global optimum. More importantly, GA appears attractive because of its superior robust behaviour in non-linear environment over other optimisation techniques. The architecture of the GA implementation can be separated into the three phase constituents viz., initial population generation, fitness evaluation and genetic operations. Based on the mechanism of natural selection and genetics, the GA is a global search technique. This algorithm can find some possible solutions simultaneously and they do not require prior knowledge or the specific nature of the objective function (Gerbex et al., 2001; El Metwally et al., 2008). In addition, they always produce high quality solutions and, therefore, they are an excellent method to find optimal solutions in complex problems. GA starts with random generation of initial population representing possible solutions of the problem. Then the fitness of each individual is evaluated and new populations are generated by genetic operators (reproduction, crossover and mutation) until the maximum number of generations is reached.

In this paper, the purpose of GA is only for comparison with the PSO in terms of accuracy and computational time. However, the problem formulation is similar to PSO

with the goal of the optimisation is to find the best location of FACTS controllers in the power systems for maximum loadability and least cost. The configuration of FACTS controllers is defined with two parameters, the location and control settings. In order to take into account the two aforementioned parameters in the optimisation, a particular coding is developed. An individual is represented with two strings. The first string corresponds to the location of FACTS controllers. It contains the numbers of buses (for SVC) or lines (for TCSC and UPFC) where the FACTS controllers are to be located. The second string of the individual represents the values of the FACTS controllers. It can take discrete values contained between 0 and 1; 0 corresponding to the minimum value that the controllers can take and 1 to the maximum.

The creation of an individual is done in the following stages. Firstly, in the first string, a set of all possible buses or lines of the power network have been selected that can be a suitable location for FACTS controllers. The second step consists of the attribution of the characteristics of the controllers. Control setting of FACTS controllers is finally randomly chosen among the possible values. Then, the objective function is computed for every individual of the population. It has to be elaborated so as to favour the reproduction of good individuals without preventing reproduction of interesting others. The move to a new generation is done from the results obtained for the old generation according to the values of the objective function of it. Further, the operators of reproduction, crossover and mutation are applied successively to generate the offsprings. These three operations are repeated until the number of desired offsprings is created. The objective function is then calculated for every offsprings and the best individuals among the entire pool, comprising parents and their offsprings, are kept to constitute the new generation. By this way, the objective function of the best individual of the new generation will be the same or higher than the objective function.

6 Simulation and discussion

To verify the suggested approach in this paper, several simulation studies have been conducted to maximise the SL along with minimise the installation cost of FACTS controllers analytically on IEEE 14, 30, and practical 24-bus Java-Bali Indonesia systems. All the FACTS controllers considered for the test system are modelled using a power system analysis toolbox (PSAT) (Milano, 2005). The parameters of both PSO and GA for all optimisation cases are summarised in Table 1.

Table 1a The PSO parameters

c_j	w_{max}	w_{min}	Number of generation/iteration	Population size
2.0	0.9	0.4	50	100

Table 1b The GA parameters

Number of offspring per pair of parents	Maximum number of generation/iteration	Population size of individual
1	50	100

13 Loads were modelled as constant power loads with a constant power factor and they were increased as per equations (9) and (10). The additional load is assumed to be met by the slack generator. The PSO and GA decision variables are the location and setting of SVC, TCSC, and UPFC. The reactance of TCSC is assumed to vary between 20% inductive and 80% capacitive of line reactance. The placement of TCSC and UPFC is considered a discrete variable, where all the lines (except line with transformer) of the system are selected as possible locations for TCSC and UPFC placement. During the power flow analysis, the TCSC is modelled as a constant capacitive reactance that modifies the line reactance X as shown in (2) (Milano, 2005). Similarly, the SVC is considered a generator (or an absorber) of reactive power and varies continuously within ± 1 pu. The optimal location of SVC is also considered a discrete decision variable, where all load buses are selected as possible location for the placement of SVC. Moreover, in this study, stability consideration means small signal stability, FVSI, and LQP security indices.

Table 2 Optimal locations, parameter settings, MSL, and optimal cost of installing FACTS controllers in IEEE 14-bus system using both PSO and GA techniques

Considered stability (Section 3.6)	Method	FACTS controllers	Location*	Settings		MSL (F_1)		C (F_2) ($\times 10^6$) US\$	Time (sec.)
				V_{FACTS} (pu)	Comp. (%)	(pu)	(%)		
No	PSO	No FACTS	-	-	-	0.7488	128.91	0	820
		TCSC	3-2	-	20	1.4184	154.77	1.0076	667
		SVC	5	1.000	-	1.4599	156.37	0.1055	689
		UPFC	14-13	0.919	20	1.4976	157.82	0.3337	367
	GA	No FACTS	-	-	-	0.6958	126.86	0	2,555
		TCSC	5-4	-	11.73	1.1430	144.13	0.0081	3,500
		SVC	12	0.97	-	0.7165	127.66	1.6238	2,179
		UPFC	14-13	0.92	-25.98	1.2597	148.64	0.7462	3,143
Yes	PSO	No FACTS	-	-	-	0.6437	124.85	0	837
		TCSC	3-2	-	20	1.2506	148.95	0.0679	688
		SVC	11	1.000	-	0.8054	131.10	0.1328	756
		UPFC	14-13	0.910	-59.75	1.3024	150.29	0.2878	435
	GA	No FACTS	-	-	-	0.6971	126.92	0	2,671
		TCSC	3-2	-	19.67	0.8524	132.91	0.0017	3,341
		SVC	5	1.02	-	1.0036	138.75	0.2716	2,160
		UPFC	14-13	0.92	-29.39	1.2914	149.86	1.3292	2,530

Note: *Line for TCSC and UPFC; bus for SVC.

6.1 IEEE 14-bus system

The IEEE 14-bus test system (Zimmerman et al., 2011) consists of two generators, located at bus-1 and 2; three synchronous compensators used only for reactive power

support at buses 3, 6, and 8, 14 buses, 20 transmission lines, and 11 loads. The location, settings of FACTS controllers and optimal installation costs are obtained using the both PSO and GA techniques for single- and multi-type FACTS controllers and are given in Table 2.

In the case of TCSC, by using the PSO algorithm, it is observed that placing TCSC in line-12 (connected between bus-3 to bus-2) gives MSL of 154.77% and 148.95%, respectively. The installation costs of TCSC are $\text{US}\$1.0076 \times 10^6$ and $\text{US}\$0.0679 \times 10^6$ for the case of without and with considering stability constraints, respectively. In the case of SVC, by incorporating the stability constraints, the MSL is reduced from 156.37% to 131.10% but installation cost slightly increased from $\text{US}\$0.1055 \times 10^6$ to $\text{US}\$0.1328 \times 10^6$, because of the different SVC locations given by the PSO are at bus-5 and bus-11, respectively.

In the case of UPFC, by using the PSO, MSL has been achieved 157.82% without stability condition and, 150.29% with stability condition, the UPFC is placed in the same line (14-13) and the installation costs are found as $\text{US}\$0.3337 \times 10^6$ and $\text{US}\$0.2878 \times 10^6$ for the case of without and with stability constraints. From the analysis, it is quite clear that the UPFC shows the best performance with the MSL of 157.82% and 150.29% without and with stability constraints. Next to UPFC, SVC stands with the MSL of 156.37% and 131.10%, respectively. TCSC gives the lowest MSL. When comparing the results by using the GA technique as shown in Table 2, it is clear that, all MSL for each FACTS controller by using the PSO algorithm are better than the GA and also with computation times quite less compare with the time using the GA technique. From the table it can be seen that by installing a UPFC in the system, with considering all of the stability constraints, the calculation time have been found of 435 second by using the PSO technique, but the computation time was increase quite large to 2,530 seconds using the GA technique. However, computational time is not important here because this study has been carried out for planning purpose not for online/real time application.

Even though the voltage profile changes with the increase in SL, the FACTS controllers are able to maintain the power flow within limits. Similarly, all the voltages are within the limits by using both the PSO and GA techniques.

Using the both techniques, it can be observed that the voltage and line stability indices, i.e., *FVSI* and *LPQ* are well within the allowed range to assure grid stability at various levels of SL as given in Figures 3 and 4, respectively. The figures show that indices of *FVSI* and *LPQ* are much less than 1.00. This indicate that grid stability is maintained at various levels of SL which ensures no bus will collapse due to overloading and no line is over loaded under any grid condition.

The eigenvalues at the maximum SL are shown in Figures 5 to 7. It is evident that the installation of FACTS controllers assures grid stability with all the eigenvalues in the left hand side of the S-plane during maximum SL. Furthermore, the graphs do not include the far end stable eigenvalues (real eigenvalue less than -0.05 using both the PSO and GA techniques) in the chart.

The results obtained by applying the PSO technique for IEEE 14-bus system is compared with the results reported in Rashed et al. (2007) and Shaheen et al. (2007) as shown in Table 3. From this table, it can be seen that installing one FACTS controller at the suitable location in the system, the MSL obtained by proposed method is 148.95% for TCSC and 150.29% for UPFC with the costs of $\text{US}\$0.0679$ million and

US\$0.2878 million, respectively. Whereas the result reported in the references, it was need five FACTS controllers for each type of the controllers to find the MSL of 122% with the installation costs of US\$0.42273 million for TCSC (Rashed et al., 2007) and US\$0.80786 million for UPFC (Shaheen et al., 2007). These costs are quite large compared with the obtained result in this work. Moreover, the results for SVC and stability constraints of the standard IEEE 14-bus test system are not reported in Rashed et al. (2007) and Shaheen et al. (2007). Therefore, the suggested approach in this paper has been found as more suitable and practical compared with reported literature for similar work.

Figure 3 FVSI after optimal placement of FACTS controllers in IEEE 14-bus system using both the PSO and GA techniques

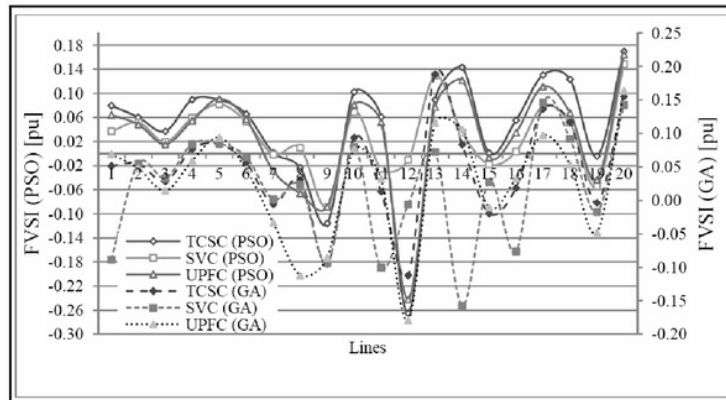

Figure 4 LQP after optimal placement of FACTS controllers in IEEE 14-bus system using both the PSO and GA techniques

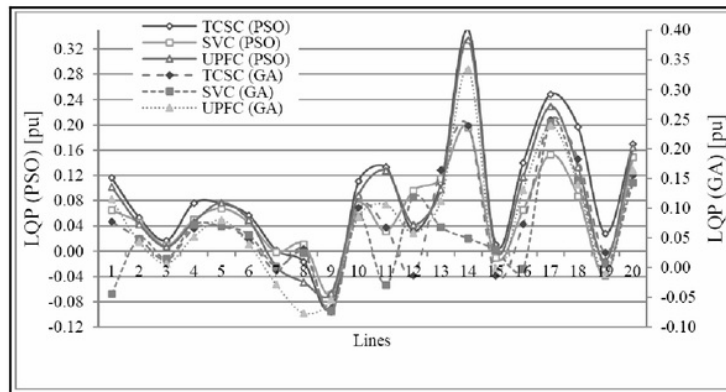

Figure 5 Eigenvalue after optimal placement of TCSC in IEEE 14-bus system using both the PSO and GA techniques (see online version for colours)

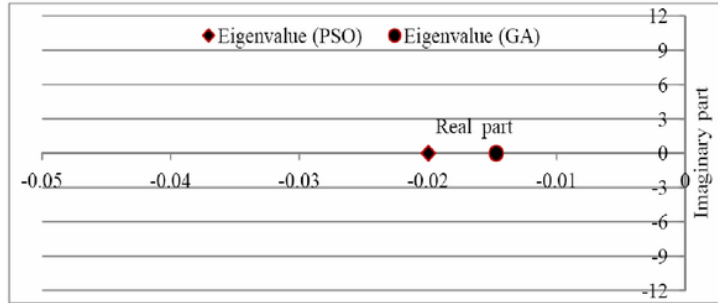

Figure 6 Eigenvalues after optimal placement of SVC in IEEE 14-bus system using both the PSO and GA techniques (see online version for colours)

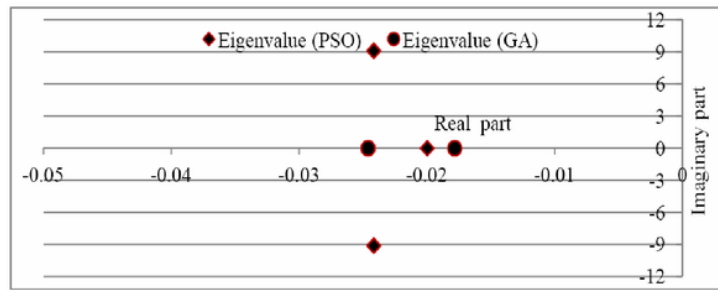

Figure 7 Eigenvalues after optimal placement of UPFC in IEEE 14-bus system using both the PSO and GA techniques (see online version for colours)

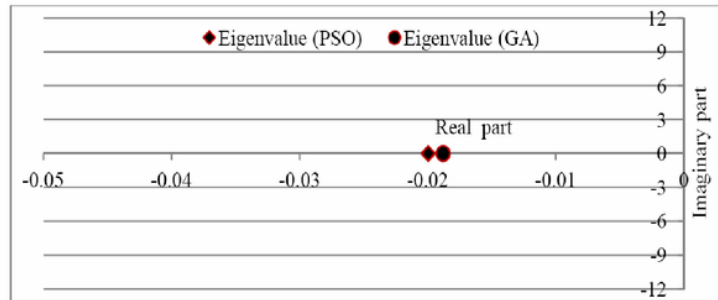

Table 3 Optimal installation cost (C), MSL, and minimum number of FACTS controllers (N) needed in IEEE 14-bus system

Type of FACTS controllers	Obtained result in this work				Result reported in Rashed et al. (2007)* and Shaheen et al. (2007)**			
	MSL (%)	N	C ($\times 10^6$) US\$	Considered stability (Section 3.6)	MSL (%)	N	C ($\times 10^6$) US\$	Considered stability (Section 3.6)
TCSC	148.95	1	0.0679	Yes	122	5	0.42273	No
SVC	131.10	1	0.1328	Yes	-	-	-	-
UPFC	150.29	1	0.2878	Yes	122	5	0.80786	No

Notes: *Case for TCSC as studied in Rashed et al. (2007).

**Case for UPFC as studied in Shaheen et al. (2007).

4 6.2 IEEE 30-bus system

The bus data and line data of 30-bus system are taken from Zimmerman et al. (2011) and Alsac and Stott (1974) and contain 41 lines. Table 4 shows the MSL, optimal cost of installation and minimum number of controllers needed for 30-bus system, obtained by using the PSO technique.

Table 4 Optimal location, parameter settings, MSL, and optimal cost of installing FACTS controllers in IEEE 30-bus system using the PSO technique

Considered stability (Section 3.6)	FACTS controllers	Location*	V_{FACTS} (pu)	Comp. (%)	MSL (pu)	(F_1) (%)	$C (F_2)$ ($\times 10^6$) US\$
No	No FACTS	-	-	-	2.1716	214.77	0
	TCSC	26-25	-	-42.62	2.5833	236.54	0.2393
	SVC	29	1.01	-	2.5004	230.00	0.0273
	UPFC	12-13	1.01	20	2.6037	237.61	0.1948
Yes	No FACTS	-	-	-	2.3220	222.74	0
	TCSC	19-20	-	20	2.5091	232.61	0.1896
	SVC	30	1.00	-	2.5943	224.98	0.1508
	UPFC	10-9	1.00	-18.98	2.5815	236.44	0.3498

Note: *Line for TCSC and UPFC; bus for SVC.

In case of without and with stability constraints UPFC improves the SL to 237.61% and 236.44%, respectively. Similarly, in both cases TCSC gives a MSL of 236.54% and 232.61% and SVC improves the SL to 216.38% and 204.61%, respectively. When comparing the costs by including stability constraints, TCSC is the best option. The system is stable at the maximum SL, using all types of FACTS controllers (TCSC, SVC, and UPFC), as shown in Figures 8 to 12.

Figure 8 FVSI after optimal placement of FACTS controllers in IEEE 30-bus system using the PSO technique

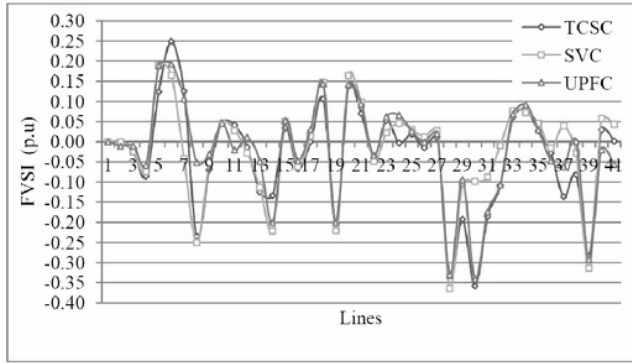

Figure 9 LQP after optimal placement of FACTS controllers in IEEE 30-bus system using the PSO technique

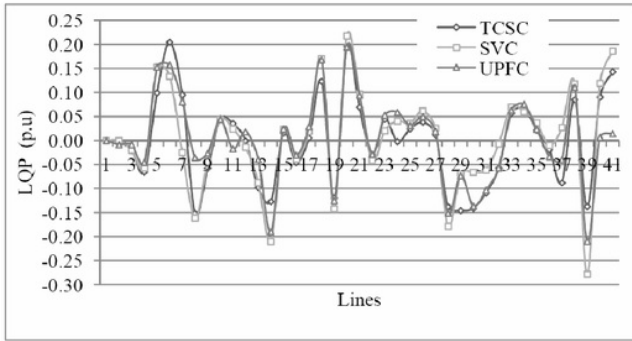

Figure 10 Eigenvalue after optimal placement of TCSC in IEEE 30-bus system using the PSO technique (see online version for colours)

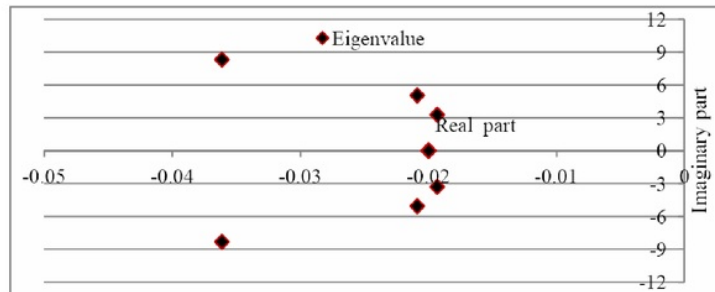

Figure 11 Eigenvalue after optimal placement of SVC in IEEE 30-bus system using the PSO technique (see online version for colours)

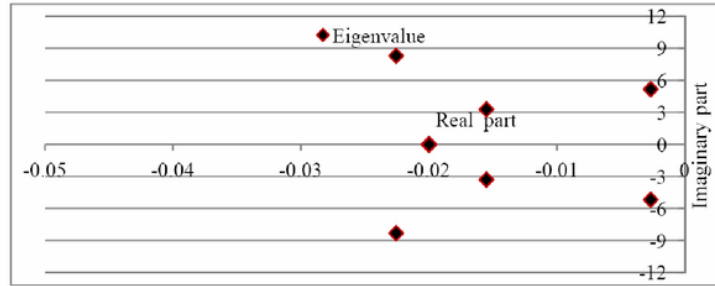

Figure 12 Eigenvalue after optimal placement of UPFC in IEEE 30-bus system using the PSO technique (see online version for colours)

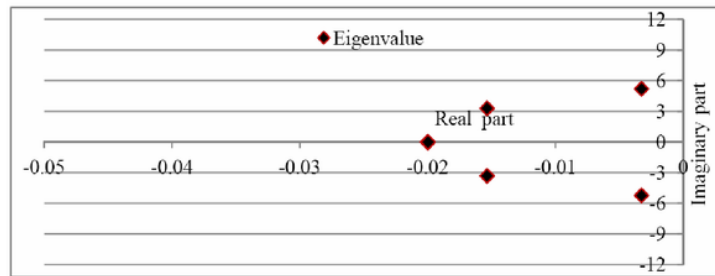

Table 5 Optimal installation cost (C), MSL, and minimum number of FACTS controllers (N) needed in IEEE 30-bus system

Type of FACTS controllers	Obtained result in this work				Result reported in Saravanan et al. (2007)			
	MSL (%)	N	C ($\times 10^6$) US\$	Considered stability (Section 3.6)	MSL (%)	N	C ($\times 10^6$) US\$	Considered stability (Section 3.6)
TCSC	232.61	1	0.1896	Yes	138	8	3.57	No
SVC	224.98	1	0.1508	Yes	128	8	0.52	No
UPFC	236.44	1	0.3498	Yes	139	8	276.7	No

The results obtained by using the PSO technique from IEEE 30-bus system is compared as well with the results reported in Saravanan et al. (2007) as shown in Table 5. From the table, it can be observed that, the MSL of FACTS controllers obtained in this study are increased of 232.61% for TCSC, 224.98% for SVC, and 236.44% for UPFC with the costs of US\$0.1896 million, US\$0.1508 million, and US\$0.3598 million, respectively. But when compare with the results reported in Saravanan et al. (2007), it required to install eight FACTS controller for each type to obtain the MSL of 138% for TCSC, 128%

for SVC, and 139% for UPFC with the costs of US\$3.57 million, US\$0.52 million, and US\$277.7 million, respectively. These can be concluded that the results obtained in this work for both the MSL and the installation costs for each type of the controllers are better than compared with the results reported in the reference. Moreover, the stability constraints of the standard IEEE 30-bus test system are not reported in Saravanan et al. (2007).

6.3 Java-Bali 24-bus Indonesian system

In order to give a more practical aspect to this study, the proposed method has been applied on the practical 24-bus Java-Bali Indonesian grid system. Single line diagram of the system is shown in Figure A1 (P3B, 2010) as given in the Appendix.

The bus data and line data are taken from the Indonesia Government Electrical Company and which has eight generators and 49 lines. The total active and reactive load of the system is 10,570.87 MW and 4,549.23 MVAR, respectively.

Table 6 shows the optimal location, parameter settings, MSL, and the optimal installation costs of the three FACTS controllers in 24-bus Java-Bali Indonesian system obtained by the both techniques, viz., PSO and GA. From this table, it has been observed that UPFC gives the highest MSL when compared with all the cases and the installation costs is also the highest.

In the case of TCSC, when compared with other two FACTS controllers, the installation costs of TCSC is minimum to attain a MSL of 163.49% and 161.49% without and with considering the stability constraints, respectively, by PSO technique. However, the installation cost for SVC is the same without and with considering stability constraints, i.e., US\$9.9870 $\times 10^6$. In all cases, the MSL obtained by the PSO technique are better than the results achieved by the GA technique in terms of accuracy as well as computational time.

Table 6 Optimal location, parameter settings, MSL, and optimal cost of installing FACTS controllers in Java-Bali 24-bus Indonesian system using both the PSO and GA techniques

Considered stability (Section 3.6)	Method	FACTS controllers	Location*	Settings		MSL (F_1)		C (F_2) ($\times 10^6$) US\$	Time (sec.)
				V_{FACTS} (pu)	Comp. (%)	(pu)	(%)		
No	PSO	No FACTS	-	-	-	47.1989	144.65	0	740
		TCSC	19-1	-	20	67.1097	163.49	0.4554	813
		SVC	24	0.93	-	74.5092	170.49	9.9870	632
		UPFC	18-19	0.94	11.82	79.7638	175.46	10.9500	362
	GA	No FACTS	-	-	-	38.1508	136.09	0	2,367
		TCSC	19-1	-	-19.86	47.7808	145.20	0.1185	2,551
		SVC	23	1.00	-	43.7197	141.36	0.1145	2,473
		UPFC	14-15	0.98	-70.89	48.3983	145.78	0.9978	2,733

Note: *Line for TCSC and UPFC; bus for SVC.

Table 6 Optimal location, parameter settings, MSL, and optimal cost of installing FACTS controllers in Java-Bali 24-bus Indonesian system using both the PSO and GA techniques (continued)

Considered stability (Section 3.6)	Method	FACTS controllers	Location*	Settings		MSL (F_1)		C (F_2) ($\times 10^6$) US\$	Time (sec.)
				V_{FACTS} (pu)	V_{FACTS} (pu)	(pu)	(%)		
Yes	PSO	No FACTS	-	-	-	47.1914	144.64	0	768
		TCSC	19-1	-	20	64.9975	161.49	1.7625	777
		SVC	24	0.95	-	67.2143	163.58	9.9870	707
		UPFC	18-19	0.95	20	76.3358	172.21	10.4751	376
	GA	No FACTS	-	-	-	27.1590	125.69	0	2,460
		TCSC	17-12	-	-	42.8138	140.50	0.0192	2,404
		SVC	22	1.01	-	45.4921	143.04	0.0446	2,061
		UPFC	19-1	0.99	20.00	47.7999	145.22	12.0812	2,250

Note: *Line for TCSC and UPFC; bus for SVC.

Figure 13 FVSI after optimal placement of FACTS controllers in Java-Bali 24-bus Indonesian system using both the PSO and GA techniques

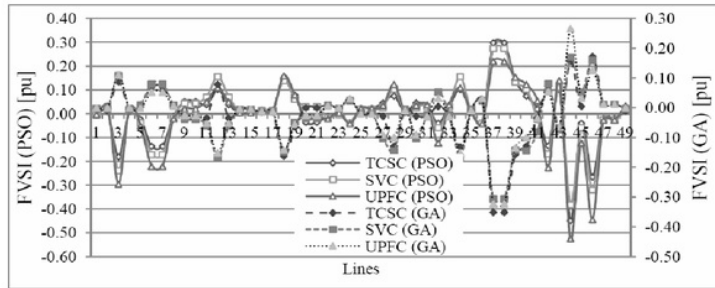
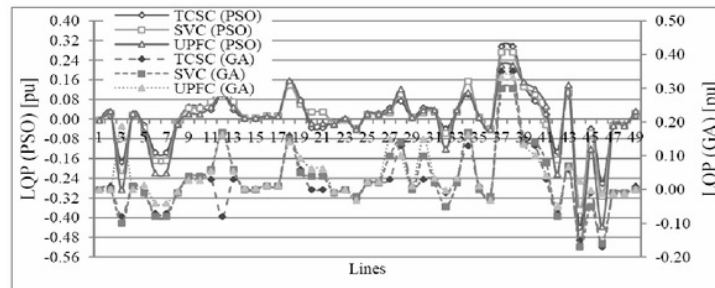

Figure 14 LQP after optimal placement of FACTS controllers in Java-Bali 24-bus Indonesian system using both the PSO and GA techniques



The stability of the system obtained by applying the both techniques in this case, represented by their FVSI, LQP, and eigenvalue results, at maximum SL using TCSC, SVC, and UPFC are depicted in Figures 13 to 17.

Figure 15 Eigenvalue after optimal placement using TCSC in Java-Bali 24-bus Indonesian system using both the PSO and GA techniques (see online version for colours)

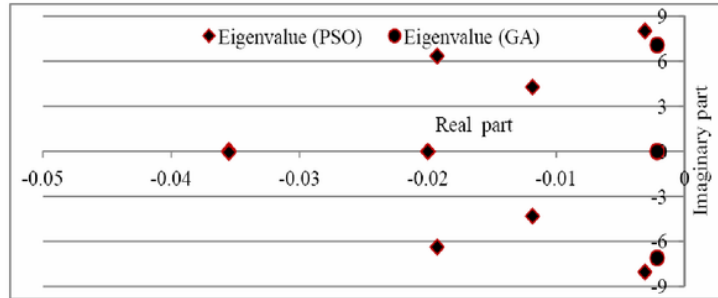

Figure 16 Eigenvalue after optimal placement using SVC in Java-Bali 24-bus Indonesian system using both the PSO and GA techniques (see online version for colours)

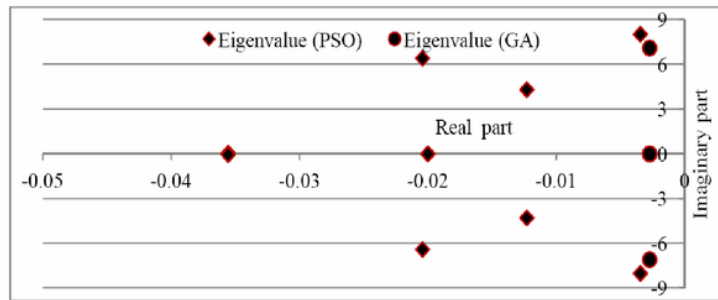
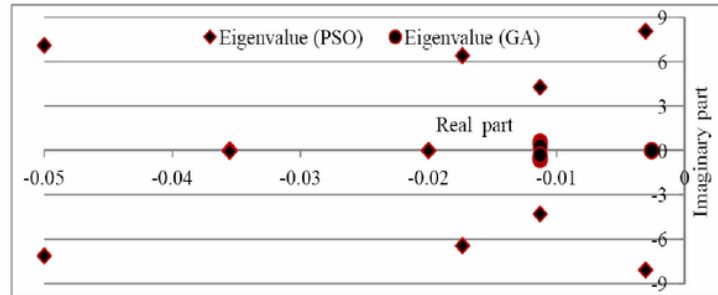

Figure 17 Eigenvalue after optimal placement using UPFC in Java-Bali 24-bus Indonesian system using both the PSO and GA techniques (see online version for colours)



7 Conclusions

In this work, the most potent evolutionary optimisation technique, i.e., PSO has been used to MSL by optimal placement of different types of FACTS controllers in the power system. Since FACTS controllers are expensive, maximising SL is subject to minimising the investment costs of the FACTS controllers. The results obtained from implementing this show that the proposed technique performed well when compared with the previous evolutionary optimisation technique namely GA and the method suggested in the literature.

This technique has superior features that include high quality solution, stable convergence characteristics, and good computation efficiency. Moreover, the results show that the system's loadability can be increased efficiently by the PSO algorithm while maintaining the security and stability within acceptable margins. Thus, all the obtained results validate and support the proposed technique.

Acknowledgements

The authors would like to thank to DIKTI-Scholarship for financial support to carry out this research, the Indonesian Government Electrical Company for supporting the data and to Professor F. Milano for the free PSAT software package.

References

- Abido, M.A. (2006) 'Multiobjective optimal VAR dispatch using strength Pareto evolutionary algorithm', in *Evolutionary Computation, IEEE Congress on CEC 2006*, pp.730–736.
- Alsac O. and Stott, B. (1974) 'Optimal load flow with steady-state security', *IEEE Transactions on Power Apparatus and Systems*, Vol. PAS-93, No. 3, pp.745–751.
- Behshad, M., Lashkarara, A. and Rahmani, A.H. (2009) 'Optimal location of UPFC device considering system loadability, total fuel cost, power losses and cost of installation', in *2009 2nd International Conference on Power Electronics and Intelligent Transportation System (PEITS)*, Vol. 2, pp.231–237.
- Benabid, R., Boudour, M. and Abido, M.A. (2009) 'Optimal location and setting of SVC and TCSC devices using non-dominated sorting particle swarm optimization', *Electric Power Systems Research*, Vol. 79, No. 12, pp.1668–1677.
- Benabid, R., Boudour, M. and Abido, M.A. (2009) 'Optimal placement of FACTS devices for multiobjective voltage stability problem', Paper presented at the *IEEE/PES Power Systems Conference and Exposition, PSCE '09*, pp.1–11.
- Bhasaputra, P. and Ongsakul, W. (2003) 'Optimal placement of multi-type FACTS devices by hybrid TS/SA approach', in *Proceedings of the 2003 International Symposium on Circuits and Systems, 2003. ISCAS '03*, Vol. 3, pp.III-375–III-378.
- Birge, B. (2003) 'PSOt – a particle swarm optimization toolbox for use with Matlab', in *Proceedings of the 2003 IEEE, Swarm Intelligence Symposium SIS '03*, pp.182–186.
- Cai, L.J., Erlich, I. and Stamtis, G. (2004) 'Optimal choice and allocation of FACTS devices in deregulated electricity market using genetic algorithms', in *Power Systems Conference and Exposition, IEEE PES*, Vol. 1, pp.201–207.
- del Valle, Y., Venayagamoorthy, G.K., Mohagheghi, S., Hernandez, J-C. and Harley, R.G. (2008) 'Particle swarm optimization: basic concepts, variants and applications in power systems', *IEEE Transactions on Evolutionary Computation*, Vol. 12, No. 2, pp.171–195.

- El Metwally, M.M. et al. (2008) 'Optimal allocation of FACTS devices in power system using genetic algorithms', *12th International Middle-East in Power System Conference, MEPCON 2008*, pp.1–4.
- Gerbex, S., Cherkaoui, R. and Germond, A.J. (2001) 'Optimal location of multi-type FACTS devices in a power system by means of genetic algorithms', *IEEE Transactions on Evolutionary Computation*, Vol. 16, No. 3, pp.537–544.
- Gyugyi, L. (1992) 'Unified power-flow control concept for flexible AC transmission systems', *Generation, Transmission and Distribution, IEE Proceedings C*, Vol. 139, pp.323–331.
- Hingorani, N. and Gyugyi, L. (2000) *Concepts and Technology of Flexible AC Transmission Systems*, 1st ed., Wiley-IEEE Press.
- Hingorani, N.G. (1993) 'Flexible AC transmission', *Spectrum, IEEE*, Vol. 30, No. 4, pp.40–45.
- Hingorani, N.G. (2000) 'Role of FACTS in a deregulated market', Paper presented at the *Power Engineering Society Summer Meeting*, IEEE, Vol. 3, pp.1463–1467.
- Jirapong, P. and Ongsakul, W. (2007) 'Optimal placement of multi-type FACTS devices for total transfer capability enhancement using hybrid evolutionary algorithm', *Electric Power Components and Systems*, Vol. 35, No. 9, pp.981–1005.
- Kennedy, J. and Eberhart, R. (1995) 'Particle swarm optimization', in *Proceedings, IEEE International Conference on Neural Networks*, Perth, WA, Australia, Vol. 4, pp.1942–1948.
- Kumar, G.N., Kalavathi, M.S. and Reddy, B.R. (2005) 'Eigen value techniques for small signal stability analysis in power system stability', *Journal of Theoretical and Applied Information Technology*, Vol. 6, No. 2, pp.181–193.
- Li, X. (2003) 'A non-dominated sorting particle swarm optimizer for multiobjective optimization genetic and evolutionary computation – GECCO 2003', *Lecture Notes in Computer Science*, Springer Berlin/Heidelberg, Vol. 2723, pp.37–48.
- Lu, Z., Li, M.S., Jiang, L. and Wu, Q.H. (2008) 'Optimal allocation of FACTS devices with multiple objectives achieved by bacterial swarming algorithm', in *Power and Energy Society General Meeting – Conversion and Delivery of Electrical Energy in the 21st Century*, pp.1–7.
- Milano, F. (2005) 'An open source power system analysis toolbox', *IEEE Transactions on Power Systems*, Vol. 20, No. 3, pp.1199–1206.
- Musirin, I. and Rahman, T.K.A. (2002) 'Novel fast voltage stability index (FVSI) for voltage stability analysis in power transmission system', in *Student Conference on Research and Development, SCORed 2002*, pp.265–268.
- P3B (2010) *The 2010 Operation Plan*, The Indonesian Government Electrical Company, PT PLN (PERSERO), Cinere, Jakarta Selatan, Indonesia.
- Povh, D. (2000) 'Modeling of FACTS in power system studies', in *Power Engineering Society Winter Meeting, IEEE*, Vol. 2, pp.1435–1439.
- Rashed, G.I., Shaheen, H.I. and Cheng, S.J. (2007) 'Optimal location and parameter settings of multiple TCSCs for increasing power system loadability based on GA and PSO techniques', in *Third International Conference on Natural Computation, ICNC 2007*, Vol. 4, pp.335–344.
- Saravanan, M., Slochanal, S.M.R., Venkatesh, P. and Abraham, J.P.S. (2007) 'Application of particle swarm optimization technique for optimal location of FACTS devices considering cost of installation and system loadability', *Electric Power Systems Research*, Vol. 77, Nos. 3–4, pp.276–283.
- Shaheen, H.I., Rashed, G.I. and Cheng, S.J. (2007) 'Application of evolutionary optimization techniques for optimal location and parameters setting of multiple UPFC devices', in *Third International Conference on Natural Computation, ICNC 2007*, Vol. 4, pp.688–697.
- Suganyadevia, M.V. and Babulal, C.K. (2009) 'Estimating of loadability margin of a power system by comparing Voltage Stability Indices', in *2009 International Conference on Control, Automation, Communication and Energy Conservation, INCACEC 2009*, pp.1–4.
- Zimmerman, R.D., Murillo-Sánchez, C.E. and Thomas, R.J. (2011) 'MATPOWER: steady-state operations, planning, and analysis tools for power systems research and education', *IEEE Transactions on Evolutionary Computation*, Vol. 26, No. 1, pp.12–19.

Appendix

Figure A1 Single line diagram of practical 24-bus Java-Bali Indonesian system (see online version for colours)

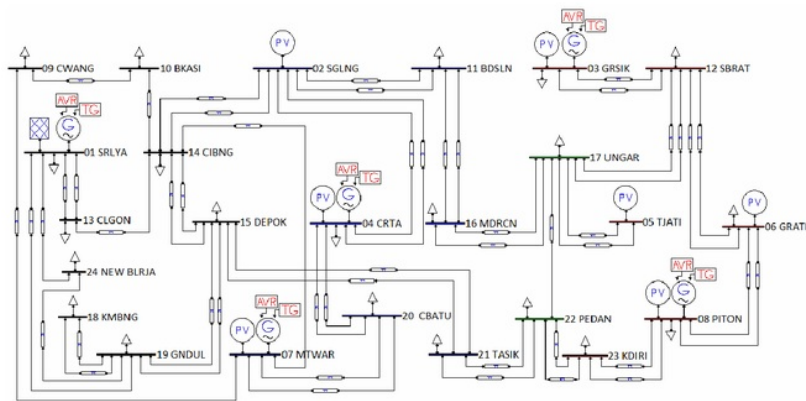

Source: P3B (2010)

Optimal placement of FACTS controllers for maximising system loadability by PSO

ORIGINALITY REPORT

19%

SIMILARITY INDEX

17%

INTERNET SOURCES

21%

PUBLICATIONS

15%

STUDENT PAPERS

PRIMARY SOURCES

1	www.ijert.org Internet Source	5%
2	iotpe.com Internet Source	1%
3	"Smart Energy Grid Design for Island Countries", Springer Nature, 2017 Publication	1%
4	M. Saravan, S.M.R. Slochanal, P. Venkatesh, P.S. Abraham. "Application of PSO technique for optimal location of FACTS devices considering system loadability and cost of installation", 2005 International Power Engineering Conference, 2005 Publication	1%
5	xplorestaging.ieee.org Internet Source	1%
6	S.J. Cheng. "Optimal Location and Parameter Settings of Multiple TCSCs for Increasing Power System Loadability Based on GA and PSO	1%

Techniques", Third International Conference on Natural Computation (ICNC 2007), 08/2007

Publication

-
- | | | |
|-----------|--------------------------------------------------------------------------------------------------------------------------------------------------------------------------------------------------------------------------------------------------------------|-----------|
| 7 | <p>G.I. Rashed, H.I. Shaheen, X.Z. Duan, S.J. Cheng. "Evolutionary optimization techniques for optimal location and parameter setting of TCSC under single line contingency", Applied Mathematics and Computation, 2008</p> <p>Publication</p> | 1% |
| <hr/> | | |
| 8 | <p>irdindia.in</p> <p>Internet Source</p> | 1% |
| <hr/> | | |
| 9 | <p>Elmitwally, Akram, Abdelfattah Eladl, and John Morrow. "Long-term economic model for allocation of FACTS devices in restructured power systems integrating wind generation", IET Generation Transmission & Distribution, 2016.</p> <p>Publication</p> | 1% |
| <hr/> | | |
| 10 | <p>S.C. Srivastava. "Placement of FACTS Controllers for Enhancing Power System Loadability", 2006 IEEE Power India Conference, 2006</p> <p>Publication</p> | 1% |
| <hr/> | | |
| 11 | <p>www.sahandtarjomeh.com</p> <p>Internet Source</p> | 1% |
| <hr/> | | |
| 12 | <p>Laifa, Abdelaziz, and Ammar Medoued. "Optimal FACTS location to enhance voltage</p> | 1% |

stability using multi-objective harmony search",
2013 3rd International Conference on Electric
Power and Energy Conversion Systems, 2013.

Publication

13

V C Chittesh, Sasidharan Sreedharan, Tibin
Joseph, P Vipin Das, Sebin Joseph, J Vishnu.
"PSO based optimal control for maximizing PV
penetration", 2014 International Conference on
Power, Control and Embedded Systems
(ICPCES), 2014

Publication

14

Suppakarn Chansareewittaya, Peerapol
Jirapong. "Power transfer capability
enhancement with multitype FACTS controllers
using hybrid particle swarm optimization",
Electrical Engineering, 2014

Publication

15

Submitted to Sharda University

Student Paper

16

www.tandfonline.com

Internet Source

17

Submitted to Sardar Vallabhbhai National Inst.
of Tech.Surat

Student Paper

18

www.europment.org

Internet Source

<1%

<1%

<1%

<1%

<1%

<1%

19

H. Rastegar. "Improvement of voltage stability and reduce power system losses by optimal GA-based allocation of multi-type FACTS devices", 2008 11th International Conference on Optimization of Electrical and Electronic Equipment, 05/2008

Publication

<1%

20

academicjournals.org

Internet Source

<1%

21

export.arxiv.org

Internet Source

<1%

22

Submitted to Higher Education Commission
Pakistan

Student Paper

<1%

23

linknovate.com

Internet Source

<1%

24

jrenewables.springeropen.com

Internet Source

<1%

25

Rashed, Ghamgeen I., Yuanzhang Sun, and H.I. Shaheen. "Optimal Location and Parameter Setting of TCSC for Loss Minimization Based on Differential Evolution and Genetic Algorithm", Physics Procedia, 2012.

Publication

<1%

26

www.zju.edu.cn

Internet Source

<1%

27

pt.scribd.com

Internet Source

<1%

28

Submitted to Universiti Tenaga Nasional

Student Paper

<1%

29

S.T. Jaya Christa. "Multi-objective optimization problem for the Thyristor Controlled Series Compensators placement with multiple decision-making approaches : MULTI-OBJECTIVE OPTIMIZATION FOR TCSC PLACEMENT", European Transactions on Electrical Power, 11/2011

Publication

<1%

30

link.springer.com

Internet Source

<1%

31

eprints.uthm.edu.my

Internet Source

<1%

Exclude quotes On

Exclude matches < 20 words

Exclude bibliography On