

Jafung_artikel-9

by Abraham Lomi

Submission date: 15-Apr-2023 11:12PM (UTC+0700)

Submission ID: 2065309980

File name: C.1.c.1-9_artikel_LOMI.pdf (428.37K)

Word count: 4063

Character count: 18827

Study of Static Under Frequency Load Shedding on IEEE 3 Generators 9 Bus System Caused of Transient Condition

Irene Budi Sulistiawati¹, Aga Dia Priasmoro¹, Abraham Lomi¹, Ardyono Priyadi²

¹Department of Electrical Engineering, Institut Teknologi Nasional Malang, Indonesia.

²Department of Electrical Engineering, Institut Teknologi Sepuluh Nopember ITS, Keputih, Sukolilo 6011, Indonesia.
Irrine_elektro@lecturer.itn.ac.id

Abstract—Electrical energy supply at generator must increase equals with the addition of load in power system. Disturbance in a system causes the system to easily turn into transient condition. This research will be performed at an IEEE 3 generator 9 bus system, where loss of generator disturbance occurs because of 3 phase short circuit in bus 3. When 3 phase fault happens, the frequency becomes 52 Hz, while the voltage becomes 161 KV or 0.7 p.u to save the system from damaged because the frequency increment, we have to release generator to decrease the frequency system. After generator was released, frequency decrease to 42.5 Hz while voltage turn to 207 KV or 0.9 p.u respectively. As a result, it was obtained that load shedding time is at fourth second with the load must be released is 92.64 MW. After load shedding, frequency becomes 49.13 Hz with frequency increase percentage as much as 13%, while the voltage becomes 241 KV or 1.049 p.u, with voltage increase percentage as much as 14.9%.

Index Terms—Frequency and Voltage; Loss Generator; Static Under-Frequency Load Shedding; Three Phase Short Circuit.

I. INTRODUCTION

Electrical energy power supply at generator must equal with the addition of load in a power system, which mean the amount of generated power and load system must be the same in any condition [1]. Disturbance in the power system can be easily turned into a transient condition. Three phase disturbances is a frequent interference, and it was used for simulation study in the system [2]. This disturbance causes circuit breaker in open condition in order to localize disturbance. If disturbance was come from near the generator, then circuit breaker near the generator will work. This condition will cause electrical energy supply from the generator to load decrease. This unbalance condition will cause system turn into the transient condition and easily to a total blackout.

Unbalance that occurred at generator side, and load side will respond with the decline of system frequency. Bad system frequency condition will make the system in collapse condition if it is not handled immediate [7] [1-11]. As we know, the blackout of power system has been a dangerous problem in an interconnected power system in recent years. There are many techniques to prevent power system from blackout [12], one of those technique called load shedding. With load shedding, we can restore the frequency and voltage in stable condition so blackout can be avoided [1-13]. The load shedding method that we used here is static under frequency load shedding. This load shedding algorithm can

be used to approach about how many load amounts need to be shed for an increased frequency by noting the rate system frequency decrease due to disturbance. The load shedding in power system can be released by using under frequency relay or manual from operator [1, 3].

Static under frequency load shedding is used to return system frequency in safety or allowable frequency. Where the contribution from this research, we will get robust reference simulation to implemented in a real system, and the results of simulations can be used to set under frequency relay or to design a reliable load shedding strategy so that total blackout can be prevented.

II. METHODOLOGY

A. Load Shedding

Load shedding is the ways to return frequency and voltage value to allowed nominal value due to disturbance. Disturbance in the system makes the system turn into transient condition. Several disturbances that make the system turn into transient condition are [4]:

- i. Loss of one or multiple generators
- ii. Loss of bus
- iii. Loss of transmission or distribution line

Those disturbances usually make the frequency and voltage decrease, so load shedding is needed to return voltage and frequency to nominal or allowed value. As in [5], it was explained that the amount of inertia generator and overload greatly affect the amount of load shedding. The electricity industry in several countries, like in Spain and Israel, still use load shedding scheme base on the observation of the frequency decay to optimize load shedding during disturbance [6].

Load shedding method that will be used here is static under frequency load shedding, where it will reduce load base on its load block in every step and load shedding will continue until the decay of frequency equals or more than zero [1]. Implementation from static load shedding needs several determined steps. The first step is determining the worst system condition during overload, then determine frequency decrease due to an overload condition. Frequency decay can help us to determine load shedding time and approach to determine the amount of load that will be shed [1, 3].

a. Allowable Frequency and Voltage

The electrical system mostly already have an allowable nominal limit of frequency and voltage [3], where referring

to the decree of the Minister of Energy and Mineral Resources of Indonesia number 3/2007, the frequency is allowed decrease until 47,5 Hz when there is an emergency situation, while voltage is allowed decrease until -10% from nominal voltage. For the top limit, the frequency was allowed increase until 52 Hz, while the voltage was allowed increase until +5% from nominal voltage. Base on those regulations, a frequency less than 47 Hz will be greatly avoided any condition. Auxiliary equipment usually works on a frequency less than 48 Hz and under speed turbine usually was arranged on frequency 47.5 Hz at operation system 50 Hz for protection [7].

b. Determine Overload

The worst possibility cases can be determined by knowing maximum overload that will be happening in the system [3]. Overload usually happen because of the loss of a generator, instantaneous loss of load, variations in load and generator [4]. The loss of one or more generator is mostly disturbance that makes overload. The formula of overload can be written as below:

$$OL = \frac{-P_{so}}{P_{GOT} - P_{SOT}} \quad \text{or} \quad OL = \frac{P_{gen} - P_{load}}{P_{gen}} \quad (1)$$

where: P_{so} = Power that was generated by disturbed unit (MW)
 P_{got} = Installed power from all generator that was operated before interference (MW)
 P_{sot} = Installed power for generator that disturbance (MW)

Keep in mind that the amount of load shed should be equal to or greater than the overload. Once the frequency drop is controlled and the frequency returns back to normal, some part of load can be restored in small increments [8].

c. Frequency Decay and System Inertia

System inertia (H) is kinetic energy in the system that is divided by installed energy in the system and state in MW-s/MVA or MJ/MVA [2, 9]. Inertia system is needed to calculate frequency decay that is explained by the following equation:

$$H = \frac{1}{2} j \omega_{sm}^2 = \frac{1}{2} \frac{M \omega_{sm}}{S_{machine}} \quad (2)$$

$$H_{system} = H_{machine} \frac{S_{machine}}{S_{System}} \quad (3)$$

where $\omega = 2 \pi f$ and f are the nominal frequency of the generator machine. If there are several generators in an interconnection system, then inertia from several generators can be written as follows:

$$H_{system} = \frac{\sum_{k=1}^N H_k \times MVA_k}{\sum_{k=1}^N MVA_k} \quad (4)$$

where H_k is inertia of generator k_{th} , VA_k is the average of apparent power from generator k_{th} and N is the amount of existed generator [3]. Generator inertia is greatly influenced

decay of frequency value, because the bigger generator inertia value, the stronger system so that frequency decrease is slower and smaller [9].

Based on total inertia calculation above we can determined decay of frequency by using the equation as follows:

$$\frac{df}{dt} = \frac{OL \times f}{2 \times H_{system}} \quad (5)$$

where: F = Frequency nominal (Hz)
 OL = Overload
 H_{net} = Rated of inertia system

d. Initial Time and Load Shed Time

Initial time is a time where frequency reach under-frequency limit [1], while load shed time is time to shed the load when frequency reaches under frequency limit. The following is an equation to get initial time value:

$$T_i = \frac{f_i - f}{\frac{df}{dt}} \quad (6)$$

where: F_i = Frequency lower limit that is allowed (Hz)
 F = Frequency nominal (Hz)
 $\frac{df}{dt}$ = Frequency decay (Hz/s)

The following is an equation to calculate load shed time:

$$T_f = T_i + T_D \quad (7)$$

where T_D is a time delay breaker to switch off the load that is used to minimize risk from temporary transient [10]. Where overload value and frequency decay after load shedding can be calculated by using the following Equation [1, 9]:

$$OL_{new} = \frac{-P_{SO} + P_{LS}}{P_{GOT} - P_{SOT}} \quad (8)$$

$$\frac{df}{dt_{new}} = \frac{OL \times f}{2 \times H_{system}} \quad (9)$$

where: P_{LS} = The amount of load that will be shed base on expected frequency decay (MW)
 $\frac{df}{dt_{new}}$ = The amount of expected frequency decay (Hz/s)

III. IMPLEMENTATION

On this research, we are using IEEE 3 generators and 9 bus, disturbance simulation of the loss generator due to 3 phase short circuit in the bus 3 will be performed. If condition above causes the changing of voltage and frequency exceed the normal limit, the generator must be released to protect the system and generator from damage. After generator was released, the frequency and voltage will decrease due to system overload. By calculating overload value, frequency decay, a time when frequency decay under allowable value and load shedding time, we can calculate the amount of load that will be shed base on frequency decrease, so it is hoped that frequency and voltage will return into allowed value. This simulation will be done by using Etap

power station software with tools transient stability analysis, where its initial load flow use Newton Raphson method and IEEE-9 bus use base voltage as much as 230 KV.

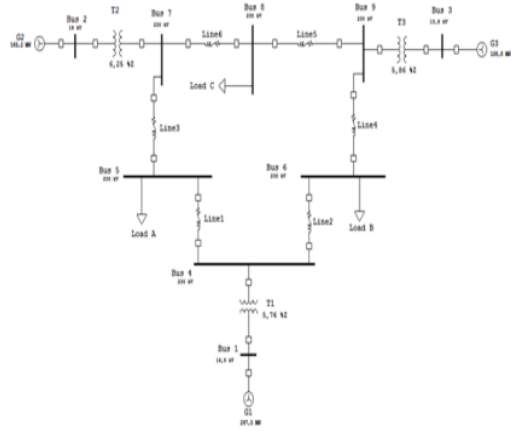

Figure 1: IEEE 9 Bus system

From Figure 1, we can know that on IEEE 9 bus system there are 3 generators and 3 static loads. Data for the generator on 3 generators and 9 bus as shown in Table 1.

Table 1
Data of generator and load

Name Generator	S(MVA)	P Gen(MW)	P Operation (MW)	H (MW-s/MVA)	Load
G1	247.5	247.5	71.337	9.55	
G2	192	163.2	163	3.33	314.67
G3	128	108.8	85	2.35	

As shown in Table 1, 3 generators 9 bus system total generation is 519.5 MW, and total load are 314.67 MW. While after load flow, power losses of the system are 4.661 MW, with the result that total demand of system as much as 319.337 MW.

IV. SIMULATION AND ANALYZE

A. System Simulation

System simulation will be done by giving disturbance of 3 phase short circuit in the system. The next step is releasing the generator to save the system and see whether system back to normal or not. The last step is calculating and simulating load shedding to restore the system back into its normal state.

This simulation of disturbance of 3 phase short circuit will be simulated at 1st second in the bus 3 to see the response of frequency and voltage in the system due to that disturbance. The response of frequency and voltage in the system due to disturbance of 3 phase short circuit in the bus 3 can see in Figure 2 and 3.

From Figure 2, it can be seen that frequency system increases to 52 Hz at bus 1 for 2 seconds during disturbance because of three-phase short circuit at 1st second. After that, frequency steady state at 50th second with frequency as much as 51.8 Hz.

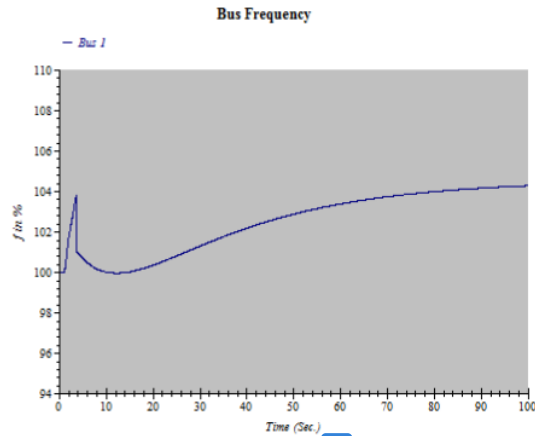

Figure 2: Frequency response during 3 phase short circuit ($t=1$ s)

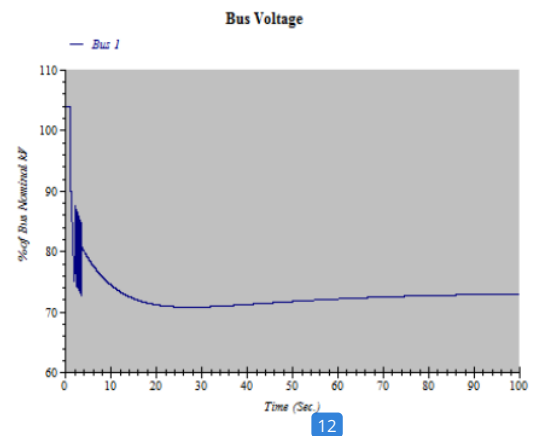

Figure 3: Voltage response during 3 phase short circuit ($t=1$ s)

Figure 3 shows voltage decrease until 0.8 p.u (184 KV) at bus 1 for two seconds. After that, voltage steady state at 0.7 p.u (161 KV) at bus 1.

To protect the system from the effect of 3 phase short circuit generator, G3 was released at 1.1th second so that the generator is expected to be safe from damage because in the operation of power system generator is a major component of the system and have the highest priority to save when there is a disturbance. The response of frequency and voltage due to the release of generator G3 can be seen in Figure 4 and 5.

Based on Figure 4, it can be seen that frequency decrease to 42.5 Hz at 16th second due to the release of G3 at 1.1th. Entering the 30th second, frequency starts to steady state at 44.5-45 Hz. The decrease of frequency happens because there is a loss of active power supply for the system from G3. So it causes unbalanced power between load and generation. Therefore, frequency system decreased.

Based on simulation when G3 is a loss from the system on Figure 5, in bus 1 voltage increase from 0.7 p.u or 161 KV (during 3 phase short circuit) to 0.9 p.u or 207 KV. Because of frequency and voltage from system below the allowable value of frequency and voltage. Therefore, load shedding needs to be done to return frequency and voltage to its allowable value.

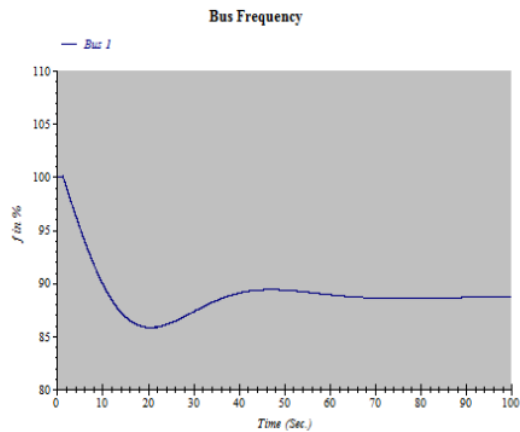

Figure 4: Frequency response when G3 out from system (t=1,1 s)

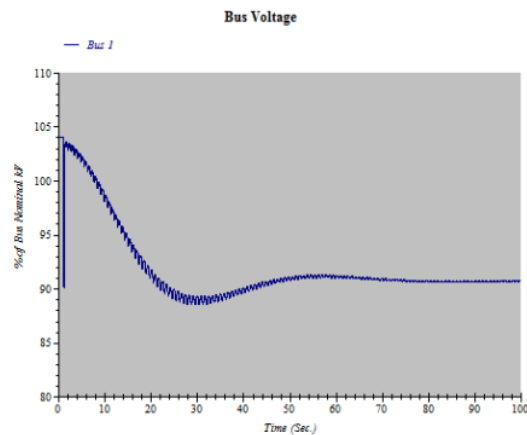

Figure 5: Voltage response when G3 out from system (t=1,1 s)

B. Static Under Frequency Load Shedding

Static load shedding is one of the most used ways to return the frequency to its nominal value during large disturbance [1, 3], based on IEEE -9 bus data, we can calculate total inertia value, frequency decay, time when frequency decline below allowable limit, load shedding time and the amount of load to be shed so that frequency can return into allowed value.

From calculation with equation 1 we can calculate the value of overload system when G3 is release from the system, then base on equation 2 and 3 we can calculate inertia generator and continued by calculation 4 to calculate inertia system. After that, we can calculate frequency decay due to the release of G3 at 1.1th second using equation 5. From that calculation we know that frequency decay when G3 lost from the system is as much as -0.8887 Hz/s, where the nominal frequency is 50 Hz.

After that, we can calculate the time when frequency approach allowed value which is 47.5 Hz by using equation 6. From that calculation, we know that frequency start approach 47.5 Hz at 3.9th second so that if we give time delay as much as 0,1 second, then we get time for load shedding at

4th second. All the calculation of five parameters in static UFLS can be seen in table 2 below.

Table 2
Static UFLS Equation

Gen	S (MVA)	H (MW-s/MVA)	H System	OL(G3 Lost)	df/dt (Hz/s)	Ti (sec)	Tf (sec)
G1	247.5	9.55					
G2	192	3.33	5.821	0.21	-0.88	2.81	4
G3	128	2.35					

In Table 2, the impact of release G3 the remaining total of generation only left 234,337 MW, with total load 314,67 MW. We can predict the rate of frequency decay about -0.88 Hz/s due to loss of power supply from G3 as much as 85 MW. From the equation in table 2 above we can say that the greater amount of generation power lost from the system then the rate of decrease in frequency will be great, it will make load shedding time faster.

It must be known that load shedding will be continued to be done until frequency decay become positive or $df/dt > 0$ [1]. Therefore, we can perform calculation approach about how many load that will be shed by doing estimation that frequency decay is considered $> 0(+)$ in Table 2. First, we can calculate overload value using Equation 8, and then we can calculate how many loads that will be shed using Equation 9.

Table 3
Load Shedding Calculation Based on Frequency Decay

df/dt(+)	2H	Over load	P load shedding(MW)
0.01		0.002328	85.95
0.02		0.004656	86.91
0.03		0.006984	87.86
0.04		0.009312	88.82
0.05		0.01164	89.78
0.06		0.013968	90.73
0.07		0.016296	91.69
0.08	11.64	0.018624	92.64
0.09		0.020952	93.6
0.1		0.02328	94.56
0.11		0.025608	95.51
0.12		0.027936	96.47
0.13		0.030264	97.42
0.14		0.032592	98.38
0.15		0.03492	99.34

Based on calculation in Table 3, load shedding time is 4th second, while the amount of load that will be shed is 92.64 with frequency decay as much as +0.08 Hz/s (the red word). Because frequency and voltage already return to the allowed value when a load that was shed as much as 92.64 MW. If we choose the frequency decay value was under or above +0.08 Hz/s, the frequency and voltage that was obtained was not maximum and exceed allowed frequency and voltage limit beside that we avoid the occurrence of overload shedding, where the load shedding will be done at bus 8.

Based on Figure 6, it can be seen that after load shedding system frequency that decreased until 42.5 Hz before because G3 lost, increase until 49.05 Hz at 20th second, with percentage as much as 13.35%. After that frequency steady state at 49.05 Hz.

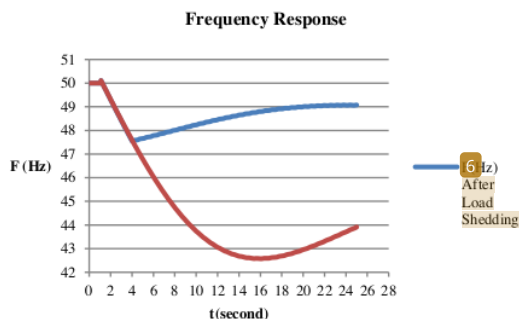

Figure 6: Frequency response before and after load shedding

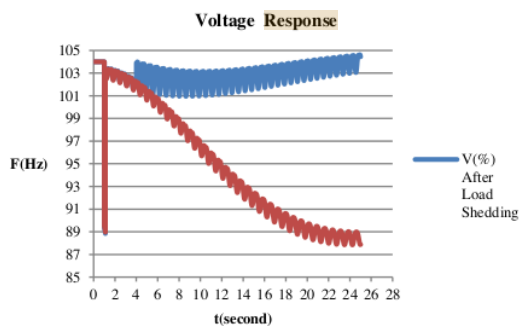

Figure 7: Voltage response before and after load shedding

Based on Figure 7, the voltage that was decreased until 0.9 p.u (207 KV) before because G3 lost, increase and steady state at 1.049 p.u (241.27 KV) at 25th second with percentage as much as 14.9% at bus 1. Base on those result, it can be said that load shedding successfully increases frequency value to the allowable value.

Frequency changing value at every second can be seen in Table 4, while voltage changing value at every second can be seen in Table 5, where sample times are starts from 0-25 seconds.

In Table 4 and 5, sampling was done at 25 seconds from frequency and voltage response at the transient condition. The steady state of the system frequency is 49 Hz at the 19th second. Therefore, the accumulative time required to return the frequency to a nominal value is about 15 seconds from the load shedding 6 time and the voltage steady state at 1.049 p.u (241.27 KV) after load shedding.

Table 4
Frequency Condition Before and After Load Shedding

Time (second)	When G3 loss F (Hz)	After load shedding F (Hz)
1	50	50
2	49.3	49.3
3	48.43	48.3
4	47.59	47.5
8	44.6	48
12	43.05	48.45
16	42.5	48.79
20	42.96	49
24	43.71	49.03
25	43.91	49.05

Table 5
Voltage Condition Before and After Load Shedding

Time (second)	When G3 loss V (p.u)	After load shedding V (p.u)	V Base (KV)
1	1.04	1.04	230
2	1.0319	1.03	
3	1.0237	1.021	
4	1.0205	1.0206	
8	0.9887	1.0301	
12	0.9429	1.0316	
16	0.9167	1.0336	
20	0.902	1.0356	
24	0.8859	1.0448	
25	0.8787	1.049	

V. CONCLUSION

A simple power system with 3 generators and 9 bus system were simulated where the loss of generator disturbance because 3 phase fault makes the frequency system decline under the permissible range. To prevent the frequency collapse and blackouts of other generators, static under frequency load shedding was simulated. Based on at 3 phase short circuit at bus 3, we know that system frequency increase until 52 Hz at bus 1, for 2 seconds. If this condition continues then system or generator will be serious damaged. Therefore generator G3 was released from the system. Base on simulation when G3 was released, frequency decrease to 42.5 Hz at 16th-second Voltage increase from 0.7 p.u (161 KV) to 0.9 p.u (207 KV) at bus 1. Therefore, load shedding was needed to return frequency and voltage value into the allowed nominal limit. After load shedding, system frequency that was decreased until 42.5 Hz when G3 is released, become 49.05 Hz at 20th second, with percentage as much as 13%. After that frequency steady state at 49.1 Hz. The voltage that decreased until 0.9 p.u (207 KV) before, increase and steady state at 1.049 p.u (241.27 KV) with percentage as much as 14.0 9%. According to simulation results, static under frequency load shedding can successfully return the frequency into allowable range.

REFERENCES

- [1] A.A Mohd Zin, W.K Wong, Static and Dynamic Under – Frequency Load Shedding: A Comparison. IEEE International Conference on Power System Technology – POWERCON, Singapore, 2004.
- [2] John J. Grainger and Stevenson, William D, Jr.,” Power System Analysis”, McGraw Hill, Inc, 1990.
- [3] Y.R Kazmi, T. Ahmed, K. Javed, A. Ghani, Static Priority Approach to Under – Frequency Based Load Shedding Schemed in Islanded Industrial Networks: Using the Case Study of Fatima Fertilizer Company Ltd - FFL, IEEE Journal of Computer, Electrical, Automation, Control and Information Engineering, vol:9, NO:3, 2015.
- [4] Y.R Omar I.Z, Abidin S, Yunus, H.A. Abdul Rasyid, Under Frequency Load Shedding (UFLS) : Principles and Implementation , IEEE International Conference on Power and Energy, Dec 1, 2010.
- [5] IEEE Std. C.37.117-2007, “IEEE Guide for The Application of Protective Relays Used for Abnormal Frequency Load Shedding and Restoration”.
- [6] M. LU, W.A.W Zainal Abidin, T. Masri, D.H.A Lee S, Under-Frequency load shedding (UFLS) scheme – A Survey, International Journal of Applied Engineering Research ISSN 0973-4562 Volume 11, Number 1 (2016) pp 456-472.
- [7] L. E. Ling, V. Wong, and N. M. Vong, “Wide Area Protection (WAP) as an Enhanced Load Shedding Scheme to Mitigate Loss of Supply to Load Center”, Conference of the Electric Power Supply Industry (CEPSI) 2010, 2010.
- [8] W. A. Elmore, Protective relaying theory and applications, Coral Springs, FL: ABB, 1994.
- [9] Marsudi, Djiteng, 2006, “Power System Operation (Operasi Sistem Tenaga Listrik)”, Yogyakarta: Graha Ilmu.

- [10] S.R. Shilling, "Electrical Transient Stability And Underfrequency Load Shedding Analysis For A Large Pump Station," IEEE Trans On Industry Application, Vol. 33, No.1, January/February 1997
- [11] H. Mokhlis, J. A. Laghari, A. H. A. Bakar and M. Karimi, "A Fuzzy Based Under-Frequency Load Shedding Scheme for Islanded Distribution Network Connected with DG" in International Review of Electrical Engineering (I.R.E.E.), Vol. 7, N pp. 4992-5000. 4 July - August 2012
- [12] D. Craciun, S. Ichim, and Y. Besanger, "A new soft load shedding: Power system stability with contribution from consumers," IEEE/PTC, pp. 1-6, June/July 2009
- [13] Shahgholian, Ghazanfar., Salary, Mahdi Ebrahimi. "Effect Of Load Shedding Strategy On Interconnected Power Systems Stability When A Blackout Occurs" International Journal of Computer and Electrical Engineering, Vol. 4, No. 2, April 2012.

Jafung_artikel-9

ORIGINALITY REPORT

8%

SIMILARITY INDEX

7%

INTERNET SOURCES

6%

PUBLICATIONS

4%

STUDENT PAPERS

PRIMARY SOURCES

1	repository.untar.ac.id Internet Source	2%
2	Submitted to Jabatan Pendidikan Politeknik Dan Kolej Komuniti Student Paper	1%
3	www.ijset.com Internet Source	1%
4	publications.waset.org Internet Source	1%
5	Waleed Khalid Shakir Al-Jubori, Doaa Ali Kaittan. "Optimum under-frequency load shedding with comparison of two load models for distribution system", AIP Publishing, 2023 Publication	1%
6	ejournal.itn.ac.id Internet Source	1%
7	zdocs.pub Internet Source	1%
8	utpedia.utp.edu.my Internet Source	<1%

9

Yong Ren, Chao Wang, Siqin Li, Long Jiao, Hongli Zhang, Fusuo Liu. "Three-stage Evolution Mechanism of Multiple Stability Problems and Control Strategies of AC/DC Power System with Large-scale Wind Turbine Generators", Energy Procedia, 2018

Publication

<1 %

10

Laghari, J.A., H. Mokhlis, A.H.A. Bakar, and Hasmaini Mohamad. "Application of computational intelligence techniques for load shedding in power systems: A review", Energy Conversion and Management, 2013.

Publication

<1 %

11

Submitted to California High School

Student Paper

<1 %

12

Esteban D. Agüero, Jaime C. Cepeda, Delia G. Colome. "FACTS models for stability studies in DigSILENT Power Factory", 2014 IEEE PES Transmission & Distribution Conference and Exposition - Latin America (PES T&D-LA), 2014

Publication

<1 %

Exclude quotes On

Exclude matches < 10 words

Exclude bibliography On