

20179-67559-1-PB.pdf

by

Submission date: 17-Mar-2021 04:41AM (UTC-0700)

Submission ID: 1535291686

File name: 20179-67559-1-PB.pdf (1.17M)

Word count: 3425

Character count: 18977

The Development of Electronics Telecommunication Remote Laboratory Architecture Based on Mobile Devices

<https://doi.org/10.3991/ijoe.v17i03.20179>

F. Yudi Limpraptono ^(✉), Eko Nurcahyo, Ahmad Faisol
National Institute of Technology, Malang, Indonesia
fyudil@lecturer.itn.ac.id

Abstract—This paper will discuss the results of research on the development of remote laboratory architectures for electronics telecommunications courses based on mobile devices. The background of study for the development of this system is to meet the demands of the world of education in the era of the industrial revolution 4.0 and the needs for online learning that is caused by the Covid-19 pandemic. Besides, with the development of cellular communication technology and mobile devices that have PC-level capabilities, mobile devices can support remote laboratory development. The design of remote laboratory system is based on an embedded system consisting of a user management server based on the Raspberry Pi 4 and an instrumentation system using Red Pitaya. Remote Laboratory applications can be accessed using mobile devices such as Android based smart phones or tablets. The aim of the development of this remote laboratory is to complete remote experiment activities in electronics telecommunications courses in the Electrical Engineering study program.

Keywords—Remote Laboratory, Mobile devices, Red Pitaya

1 Introduction

Laboratory plays an important role in completing the learning objectives given to students, especially in engineering education. In the last two decades, remote laboratories have developed rapidly. Based on the type, laboratories can be categorized into four types, namely "hands-onlab", "remote lab", "local simulation", and "virtual lab". A simple definition of remote laboratory is a physical laboratory that can be controlled remotely by the user [1].

Remote laboratory has several advantages, such as: the laboratory performance will be better and more efficient because students can use it for 24 hours. A remote laboratory supports independent learning [2], allows to use by handicapped student, supports resource sharing and collaboration between laboratories [3] [4].

The development of cellular communication technology and mobile devices that have PC-level capabilities today, has contributed to the development of a mobile-based remote laboratory system architecture. Mobile learning (M-learning) represents

the use of mobile technology, either alone or combination with other information and communication technology, to enable learning anytime and anywhere. M-learning as evolution of distance learning and e-learning is using mobile technologies [5].

P. Bistak [5] has published “Mobile Application for Remote Laboratories”, this paper discussed about a mobile application for remote laboratories that can support the education of control engineers. The design of the mobile application respects the limitations of mobile devices and it is shown that the mobile client application is capable to fulfill the variety of tasks that are required in the role of a remote user interface. A.A. Benattia [6] proposed remote laboratory via interactive mobile technology application in electronics learning. The system prototype and architecture is allowing access via mobile device, for conducting remote experiments on electronic assembly configuration and measuring instrument control. The prototype is integrated with an LMS (Moodle). J.B. Silva [7] has published “A Mobile Remote Experimentation Environment for Basic Education”, this paper discussed a brief report on a pilot project that seeks to exploit this new educational opportunity, for the implementation and deployment of collaborative virtual environment platform for teaching and learning that allows working with real physical systems through the internet, based on the concepts M3E, open digital content, open-source software and open platform hardware. The hardware for the experiment’s automation is based on Raspberry Pi with GNU Linux operating system. The RExMobile app is based on MRE and is compatible with devices running Android. M. Krbecek [8] provides solution for optimization of remote laboratories based on mobile device. A problem that often arises is the use of unsupported Java applets on mobile devices. The solution is to apply JavaScript technology in the combination with the HTML5 web socket chosen instead of the appropriate applet.

In this paper, we propose a development of a remote laboratory architecture based on mobile devices that is used to provide electronics telecommunications experiment. The remote laboratory architecture developed consists of a server based on the Raspberry Pi 4 embedded system with the Raspbian operating system. The server functions as a remote laboratory control and runs user management applications. The electronics telecommunication experiment module is equipped with a Red Pitaya web-based instrumentation system, which has an oscilloscope and frequency generator facilities that can be controlled remotely with a web-based application. The design of remote laboratory application user interface is using Android-based applications.

This paper is organized as follows: section 2 contains of the architecture of the remote laboratory; section 3 contains of result and discussion; and section 4 is conclusions.

2 Architecture of Remote Laboratory

2.1 Introduction

The development of this remote laboratory is a research project funded by the Ministry of Research and Technology of the Republic of Indonesia entitled the Develop-

ment of Remote Laboratory Architecture as a Learning Solution in the Era of Industrial Revolution 4.0. This research was conducted for 3 years (2019-2021) and is currently the second year of the research. The remote laboratory architecture is developed from previous studies that have been published entitled "New Architecture of Remote Laboratories Multiuser based on Embedded Web Server" [4] in 2013, "Development of the remote instrumentation systems based on embedded web to support remote laboratory" [9] in 2016 and "Remote Spectrum Analyzer based on Web Software Defined Radio for Use in Telecommunication Engineering Remote Laboratory" [10] in 2018.

The first year of the research has produced an integrated concept between remote laboratory with Moodle's learning management system (LMS) and the aggregator SPADA Indonesia. SPADA Indonesia is an Indonesian online learning system, which is an aggregator used to connect higher education LMS throughout Indonesia. Through this aggregator all online learning data will be recorded and the activities can be presented and recorded in SPADA Indonesia. The concept of system integration is shown in Figure 1.

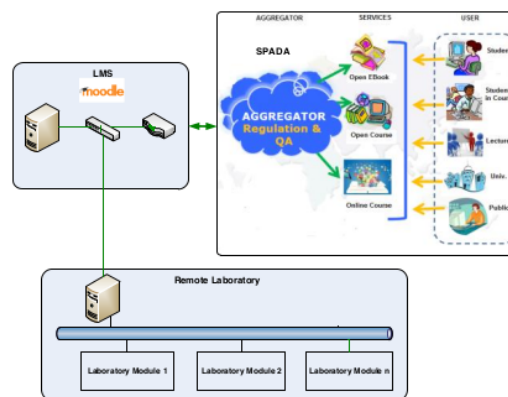

Fig. 1. Integration of SPADA, LMS and Remote Lab

2.2 Design of remote laboratory

The remote laboratory architecture consists of 3 parts. The first is an embedded web server based on Raspberry Pi 4 with the Raspbian operating system. This server functions to control the hardware of the electronics telecommunication experiments module and functions as a remote laboratory user management. Server applications include Apache web server, MySQL database server and RESTful server. The second is the hardware for the electronics telecommunication experiments module, consisting of several modules such as a series of filters, oscillators, mixers, etc. The third is the Red Pitaya web-based instrumentation system that provides several facilities, including an oscilloscope, signal generator, spectrum analyzer and multi-tester. The instru-

mentation system can be controlled remotely via a web-based application that has been provided by Red Pitaya. The design of remote laboratory system diagram is shown in Figure 2.

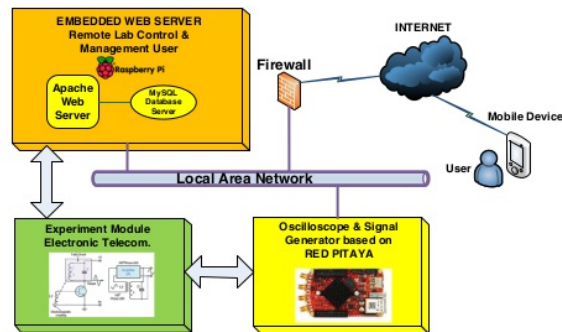

Fig. 2. Design Remote Laboratory

2.3 Hardware platform

Embedded web server: The hardware used to control the experiments module is the embedded Raspberry Pi 4 system, which is a computer based on a system on chip (SoC). Raspberry Pi 4 has the following features: Broadcom BCM2711 processor (1.5 GHz quad-core Arm Cortex-A72 CPU), 2GB RAM, a Gigabit Ethernet and two USB 2.0 ports and two USB 3.0 ports, 40 pins GPIO, wifi 802.11ac and Bluetooth 5.0 on board, microSD card data storage up to 64GB, HDMI port and using the GNU-Linux based operating system. Raspberry Pi 4 board is shown on Figure 3.



Fig. 3. Raspberry Pi 4

Red pitaya: Red Pitaya is an open-source hardware project created as a laboratory measurement instrumentation and control instrument. The main advantages of Red Pitaya are 2 RF inputs with a sampling rate of 125MS / s and 2 RF outputs with an analog bandwidth of 50 MHz. Red Pitaya has a 14 bit analog-to-digital (ADC) and digital-to-analog (DAC) converter. The software provided by Red Pitaya includes an

oscilloscope, spectrum analyzer, signal generator, LCR meter, and PID controller. Red Pitaya hardware can be reprogrammed to function as another device, this is because all IO ports are connected to a programmable FPGA. The system also has additional ADC (250kS / s) and digital IO. Red Pitaya has three USB 2.0 ports, Wi-Fi and an Ethernet connector. The Red Pitaya operating system uses Linux and the storage device for the operating system is a micro-SD card. Red Pitaya has a web-based user interface so that it can be accessed by users remotely via the internet. The Red Pitaya board is shown in Figure 4, and the web user interface is shown in Figure 5.

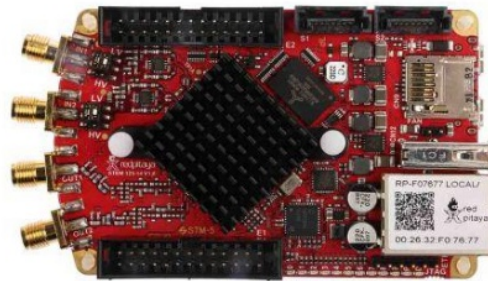

Fig. 4. Red Pitaya

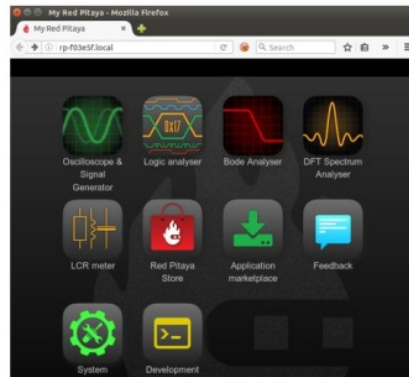

Fig. 5. Web UI Red Pitaya

Experiment module: The experimental module design can be divided into two main parts; the first part is the experimental module and the second is a switching unit. The experimental module is intended for practical activities in electronics telecommunication courses such as LPF, BPF and HPF filter circuits, oscillator circuits, mixer circuits, RF amplifier circuits etc. The switching unit is a switching circuit used to select an experimental module and to connect the input and output circuits to the

Red Pitaya instrumentation unit. The switching unit is controlled by the Raspberry Pi 4 according to the commands given by the user remotely via the web interface.

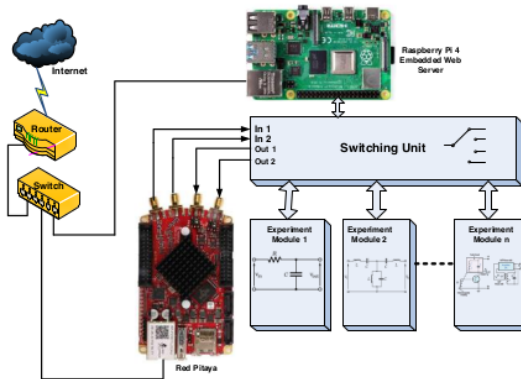

Fig. 6. Experiment Module

2.4 Software architecture

The design of software architecture can be described in Figure 7. The architecture is divided into two main parts, namely the server side and the client side. The server side is a Raspberry Pi 4-based server with the Raspbian Linux-based operating system. The server runs several server applications, namely the web server using the Apache web server, the database server using MySQL Server and to support mobile applications using the RESTful server application. Meanwhile, the client side gets a mobile application developed with the Dart programming language and uses the flutter framework.

To transmit data from the database to the mobile application or vice versa, RESTful API technology is used. By using the RESTful API, interoperability/ interaction between applications or between different devices can be done via the internet network. The way it works is as follows: the application on a mobile device will send a data request via internet network media by including the URL address of the RESTful API, then the REST Server will respond to the request by looking for data, if the data is available then the server will respond and send the data to the client (mobile device) in JSON data format. The client application that receives a response from the server will process the data and display it on the user layer.

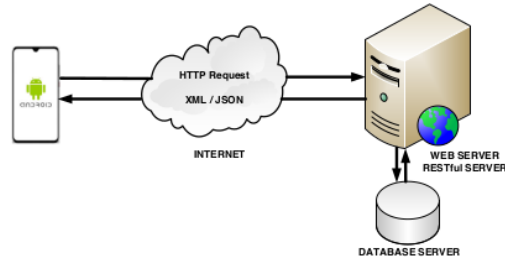

Fig. 7. Rest Webservice

3 Results and Discussion

This part will explain the steps in running and accessing a remote laboratory of electronics telecommunication. The first step is to run the mobile-based Remote Laboratory application. On the first screen, 2 menus are provided, namely SIGN IN and SIGN UP. If the user has registered, they can log in directly to the Remote Laboratory system, if they have never registered before, the user can register via the SIGN-UP menu. On the Register menu, users can fill in their username, name and password data, the Login menu is shown in Fig. 8.

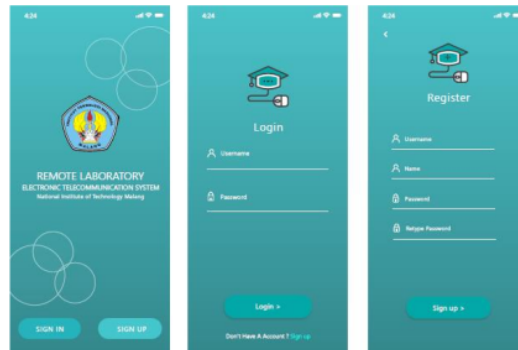

Fig. 8. Login Menu

Users who have done SIGN UP must fill in reservation data which consists of selecting the experiment date, selecting the experiment module and determining the experiment session, where each session is set for 2 hours, and during one day there are 12 sessions that can be used by the users. If one user has a reservation in a trial module with a specified session and date, then other users will not be able to make a

reservation on the date with the same session and experiment module. The remote laboratory reservation menu is shown in Fig. 9.

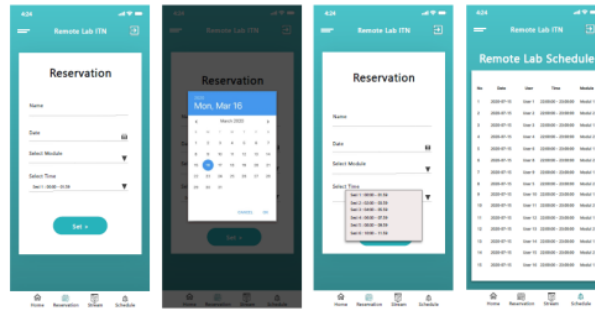

Fig. 9. Reservation Menu

Remote laboratory users can log in and enter the experiment module if the date and session match the data that was previously reserved, if the login is successful then the user will have a 2-hour session. Users can enter the web view experiment module using the web interface as shown in Fig. 10. Users can interact with the experimental module hardware by clicking on the hyperlink provided. For example, in Fig.10., If we click on the [Band Pass Filter](#) hyperlink, a display of the oscilloscope instrumentation and signal generator based on red pitaya will appear on the screen of the user's mobile device as shown in Fig.11.

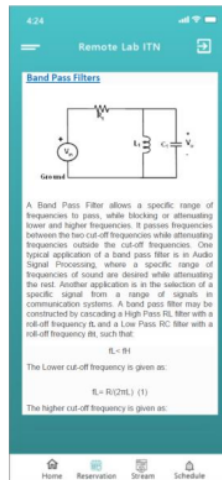

Fig. 10.Experiment Web View

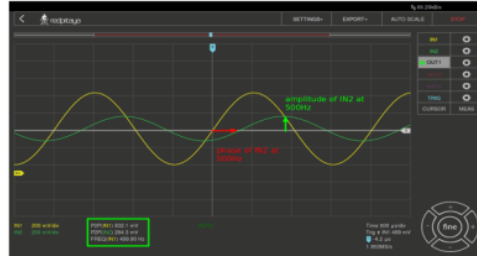

Fig. 11.Red Pitaya Instrumentation Menu

Fig. 11 is the display of a Red Pitaya instrumentation menu which has 2 oscilloscope inputs and 2 signal generator outputs. The user can set the parameters of the oscilloscope such as showing or hiding the curve corresponding to the input channel (IN1 or IN2), displaying a graphical reflection of the X axis, probe attenuation, vertical offset and input attenuation. Meanwhile, the signal generator settings consist of wave forms such as SINE (sine), SQUARE (rectangle), TRIANGLE (triangle), SAWU (rising sawtooth), SAWD (falling sawtooth), DC and PWM (Pulse Width Modulation). Trigger allows the user to select an internal or external trigger for the generator. The output signal frequency, output signal amplitude, DC offset, phase between the two output signals, and the PWM signal duty cycle.

The image of the remote laboratory system hardware is shown in Fig12. The experiment module consists of several kinds of experiments such as passive filter circuits, oscillator circuits, amplifier circuits and frequency generator circuits. The user can select a series of experiments via the web view page by clicking on the hyperlink. The control panel switching process for selecting the experimental circuit and changing the connection between the experiment circuit and the input/output of the red pitaya instrumentation equipment was carried out by the Raspberry Pi 4.

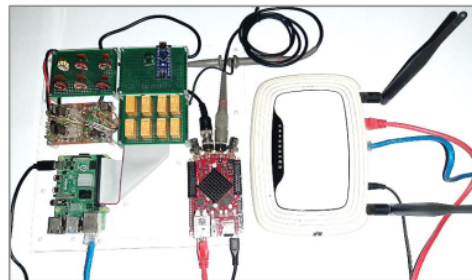

Fig. 12.Remote Laboratory System

4 Conclusion

From the test results of this research project, it can be concluded that the electronics telecommunication remote laboratory in principle can run well.

- Remote laboratory can be accessed with a mobile device, a smart phone or tablet, but a tablet device is much more suitable/ comfortable to use for experimenting compared to using a smart phone because a larger tablet display screen will make it easier to adjust the red pitaya instrumentation menu buttons.
- The use of Red Pitaya, which is applied as instrumentation equipment for remote labs, provides several advantages, including a more economical, compact, and stable remote lab system. With many instructional features that Red Pitaya has, it makes remote labs more efficient and has better performance.
- Raspberry Pi 4 as a controller for the experiment module and as a remote lab server can run very well and provide advantages for a very efficient remote lab design because of very low power requirements, very cheap prices and small dimensions with very powerful capabilities.

5 Acknowledgement

The authors would like to thank to the Indonesian Ministry of Research and Technology, which provided the funds for the research project in year 2020. The authors also thank to the National Institute of Technology Malang, which support of our research.

6 References

- [1] D.A.H. Samuelson, J. Bjork, O.H. Graven. (2014). Work in Progress: Simple software solution for accessing remote lab on mobile devices. 2014 International Conference of Teaching, Assessment and Learning (TALE), 2014 IEEE, pp 69-72 <https://doi.org/10.1109/tale.2014.7062588>
- [2] L. Gomes and S. Bogosyan, (2009). Current Trends in Remote Laboratories, IEEE Transactions on Industrial Electronics, vol. 56, no. 12, pp. 4744-4756 <https://doi.org/10.1109/tie.2009.2033293>
- [3] J. Garcia-Zubia, D. Lopez, P. Orduna. (2005). Evolving towards better architectures for remote laboratories: a practical case. International Journal of Online Engineering (IJOE), vol. 1, no.2
- [4] F.Y. Limpraptono, A.A.P. Ratna, H. Sudibyo. (2013). New Architecture of Remote Laboratories Multiuser based on Embedded Web Server. International Journal of Online Engineering (IJOE), vol. 9, issue 6, pp 4-11 <https://doi.org/10.3991/ijoe.v9i6.2886>
- [5] P. Bistak. (2015). Mobile Application for Remote Laboratories. 2015 3rd Experiment International Conference (exp.at'15), 2015 IEEE, pp 276-281 <https://doi.org/10.1109/expat.2015.7463279>
- [6] A.A. Benatia, A. Benachenhou. (2014). Remote Laboratory via Interactive Mobile Technology Application in Electronics Learning. 2014 International Conference on Interactive

- Mobile Communication Technologies and Learning (IMCL), 2014 IEEE, pp 373-375 <https://doi.org/10.1109/imctl.2014.7011105>
- [7] J.B. Silva et.al. (2015). A Mobile Remote Experimentation Environment for Basic Education. 2015 3rd Experiment International Conference, 2015 IEEE, pp 120-121
- [8] M. Krbecek, F. Schauer. (2016). Optimization of Remote Laboratories for Mobile Devices. 2016 International Conference on Interactive Mobile Communication, Technologies and Learning (IMCL), 2016 IEEE, pp 1-2 <https://doi.org/10.1109/imctl.2016.7753759>
- [9] F.Y. Limpraptono, I.S. Faradisa. (2016). Development of the remote instrumentation systems based on embedded web to support remote laboratory. Proceedings of Second International Conference on Electrical Systems, Technology and Information 2015 (ICESTI 2015), Springer, Singapore, pp 537-543 https://doi.org/10.1007/978-981-287-988-2_60
- [10] F.Y. Limpraptono, E. Nurcahyo. (2018). Remote Spectrum Analyzer based on Web Software Defined Radio for Use in Telecommunication Engineering Remote Laboratory. Journal of Telecommunication, Electronic and Computer Engineering, vol. 10, issue 2-3, pp 79-82

7 Authors

F. Yudi Limpraptono received the Bachelor's degree in Electronics from Brawijaya University, Malang, in 1994. His Master degree in Embedded System and Ph.D. degree in Computer Engineering both from the University of Indonesia obtained in 2000 and 2015 respectively. Currently, Dr. F. Yudi Limpraptono, ST, MT, is a Lecturer and researcher in Electrical Engineering Department, Faculty of Industrial Technology, National Institute of Technology, Malang, East java, Indonesia. His area of research interest includes Embedded System Applications, Remote Laboratory, Electronic Telecommunication and Green Computing Technology, and member of IEEE since 2010. fyudil@lecturer.itn.ac.id

Eko Nurcahyo received the Bachelor's and Master degree in Electrical Engineering from National Institute of Technology Malang, obtained in 1987 and 2012 respectively. Currently, Eko Nurcahyo is a head of Diploma of Electrical Engineering, National Institute of Technology Malang. His area of research interest includes power electronic and power management. ekonur@lecturer.itn.ac.id

Ahmad Faisol received the bachelor's degree from National Institute of Technology Malang and master degree in Computer Engineering from Brawijaya University, obtained in 2008 and 2014 respectively. Currently, Ahmad Faisol is a head of Computer Programming Laboratory Department of Electrical Engineering, National Institute of Technology Malang. His area of research interest includes information systems, web and mobile programming, and decision support system. mzfais@lecturer.itn.ac.id

Article submitted 2020-12-01. Resubmitted 2021-01-12. Final acceptance 2021-01-14. Final version published as submitted by the authors.

ORIGINALITY REPORT

8%

SIMILARITY INDEX

0%

INTERNET SOURCES

8%

PUBLICATIONS

%

STUDENT PAPERS

PRIMARY SOURCES

- 1** Pavol Bistak. "Mobile application for remote laboratories", 2015 3rd Experiment International Conference (exp.at'15), 2015 **3%**
Publication
- 2** "Proceedings of Second International Conference on Electrical Systems, Technology and Information 2015 (ICESTI 2015)", Springer Science and Business Media LLC, 2016 **3%**
Publication
- 3** Juarez Bento da Silva, Priscila Cadorin Nicolete, Marta Adriana da Silva Cristiano, Jose Pedro Schardosim Simao et al. "A mobile remote experimentation environment for basic education", 2015 3rd Experiment International Conference (exp.at'15), 2015 **3%**
Publication

Exclude quotes Off

Exclude matches Off

Exclude bibliography Off