

Design and Performance of Multistage Axial Flux Permanent Magnet Generators

by Eko Yohanes Setyawan

Submission date: 17-Feb-2021 12:00PM (UTC+0700)

Submission ID: 1511306700

File name: Axial_Flux_Permanent_Magnet_Generators_Jurnal_Intrnasional.pdf (1.16M)

Word count: 11887

Character count: 58068

Design and Performance of Multistage Axial Flux Permanent Magnet Generators

¹Yusuf Ismail Nakhoda, ¹Choirul Soleh, ¹Nurudin and ²Eko Yohanes Setyawan

¹Department of Electrical Engineering, National Institute of Technology Malang, Indonesia

²Department of Mechanical Engineering, National Institute of Technology Malang, Indonesia

Key words: Permanent magnets, axial flukes, multiple generators, aluminum, electric power

Abstract: Population growth and housing needs are growing rapidly, causing electricity providers to have to increase electric power capacity. Under these circumstances, innovation of generators or micro scale power plants is needed. This research aims to design Axial Flux Permanent Magnet Generators which have 4 Rotors and 4 Stators. This generator is planned to have a low rotation of 500 RPM with an planned output voltage of 49.7 V with a disc-shaped construction, using a bar magnet and a neodymium-iron-boron NdFeB magnet attached to the material in the form of a disc. This disc is made of acrylic and aluminum as a lightweight base that rotates on its axis to cause a magnetic field to produce electrical energy. In measuring voltage with a speed of 500 RPM and using 4 generators, the highest voltage on generator 1 is 21.10 V with a frequency of 51.70 Hz. In the measurement of no-load multi-stator and multi-rotor generators, an output voltage of 48.1 V is generated with a frequency of 51.70 Hz. In measurements on a multi-stator and multi-rotor generator with a load of 40 W, a voltage of 45.2 V is generated with a current of 0.06 Amperes. At a load of 80 W a voltage of 43.3 V is generated with a current of 0.14 Amperes, while a load of 120 W produces a voltage of 41.5 V with a current of 0.21 Amperes.

Corresponding Author:

Eko Yohanes Setyawan

Department of Mechanical Engineering, National Institute of Technology Malang, Indonesia

Page No.: 2604-2610

Volume: 15, Issue 12, 2020

ISSN: 1816-949x

Journal of Engineering and Applied Sciences

Copy Right: Medwell Publications

INTRODUCTION

Currently, population growth in Indonesia grows rapidly and accompanied by housing growth, making electricity providers have to increase the power capacity of the existing one. This situation led to the innovation of generators or micro scale generators which are considered helpful^[1]. Generator as the first mover is still very little in use. Various regions in Indonesia which have many renewable energy sources in the form of water energy also do not utilize this potential optimally. In fact, a

micro-hydro power plant is a type of renewable power plant that is environmentally friendly, easy to operate and low operating costs. Initial survey results in river in Manokwari, Indonesia shows that the river has a hydraulic potential of around 29.5kW. Micro-hydro power plants have been planned at this location. The power plant will use a hydraulic potential of 25.2 kW based on a flow rate of 0.3 m³ s and a head height of 8.6 m^[2].

The use of small-scale generators is considered very helpful if it is well developed as the generators are easy to maintain and control and the materials are easily

found^[3-5]. Generators that are on the market today are generators that have high RPM and require initial electrical energy to create a magnetic field. The harmonic step-time generator model is applied to electric induction and mechanical rotor generators for error measurement, and^[6] proposes analytic expressions of simple closed shapes to illustrate. The prediction was then validated by testing on a 30 kW induction generator test rig^[6].

Generators that are made must be inexpensive and easy to maintain. The generator that will be developed is Axial Flux type. Axial flux Permanent Magnet Synchronous Generators (PMSG) are designed as double and triple rotor stators, while their electromagnetic and structural characteristics are analyzed. The design aims at axial flux generators placed to the single end of the inner rotor of the engine and permanent magnets placed to the double ends of the middle rotor. One rotor is more than the number of stators used here^[7, 8], those are generators with Axial Flux Permanent Magnets 4 Stator 4 Phase 1 Rotors. This design can help in the generation of energy as it is driven by one axis and issued one phase on each side of the stator^[9, 10].

This designed generator can be implemented in low flow water turbines and act as a renewable energy which currently has many variations in the development and manufacture of various applications^[11]. The shape of the disc makes it easier to manufacture with permanent magnet variations and the number of turns. The more magnets and the number of coils the better the voltage^[12, 13].

The number of stators and rotors will affect the results of the generator output created. The more stators and rotors you have the more output you will get. One generator has many outputs that can be used in implementation^[14]. This study explains the performance of generators that have one phase output on both sides which makes each output can be used to load directly because it is one phase.

MATERIALS AND METHODS

Methods and engine design

Planning of generator speed: The stator coil (the stator is an alternator component that has the function to produce Alternating Current (AC)) is fixed or fixed to the stator core and is bound to the house so that it does not rotate (static).

The stator coil consists of 12 coils of insulated wire wrapped around a slot around the stator core. Each roll has^[15] same number of turns. The relationship between the speed of the stator rotational field (rpm) and the frequency of the generator which is inversely proportional to the number of poles based on the rotation per minute can be determined in the following way:

$$n_g = \frac{120 \times f}{p} \text{ (rpm)} \quad (1)$$

Where:

n_g = The generator speed (rpm)

f = Frequency (Hz)

p = Represents the number of magnetic poles in the stator

Permanent magnet rotors: This design uses rotor from aluminum coated acrylic material with a diameter of 30 cm²; the rotor is designed to produce 12 poles with neodymium magnets. The design of this axial flux generator rotor uses neodymium magnets by determining the quantities using the following equation:

Maximum flux density: The maximum magnetic flux density values are:

$$B_{max} = B_r \times \frac{L_m}{L_m + \delta} \text{ (T)} \quad (2)$$

Where:

B_{max} = Represents the flux density (T)

B_r = The residual induction (T)

L_m = The magnetic height (m)

δ = The air gap (m)

Extensive magnetic field: Designing the location of permanent magnets on the generator rotor as follows:

$$A_{magn} = \frac{\pi(ro^2 - ri^2) - \tau f(ro - ri) N_m}{N_m} \text{ (m}^2\text{)} \quad (3)$$

Where:

A_{magn} = Magnet area (m²)

π = phi (3.14 or 22/7)

r_i = Represents the inner radius of the magnet (m)

r_o = The outer radius of the magnet (m)

τf = The distance between magnets (m)

N_m = The number magnetism

Maximum flux: To find the maximum flux of the permanent magnet produced, the following equation is used:

$$\phi_{max} = A_{magn} \times B_{max} \text{ (Wb)} \quad (4)$$

Where:

ϕ_{max} = The maximum flux (Wb)

A_{magn} = The area of the magnet (m²)

B_{max} = The flux density (T)

Number of stator coils: While the number of stator coils (Ns) needed for the stator is used the following equation:

$$N_s = p \times \frac{N_{ph}}{2} \quad (5)$$

Where:

- N_s = The number of stator coils
- N_{ph} = The number of phases
- p = The number of magnetic poles

Number of stator coils: Copper wire is one of the many types of electrical conductors based on the material. This type of wire is the first metal used as wire and cable material. The function of copper wire is often used for winding materials in electric generators. Determining the number of turns (N) is one of the most important things in the design of radial flux generators. The number of turns is influenced by several parameters such as the area of the soft iron core to be used. If the area of the iron core is fixed and the number of turns increases the smaller the copper wire used and vice versa, the less the coil the greater the size of the copper wire.

Induction voltage: The voltage from the generator induction of the generator being generated can be calculated using the following equation:

$$E_{rms} = 4.44 \times N \times f \times \phi_{max} \times \frac{N_s}{N_{ph}} \quad (6)$$

Where:

- E_{rms} = The voltage from the generator induction (V)
- N = Represents the number of turns
- f = The frequency (Hertz)
- ϕ_{max} = The maximum flux (Wb)
- N_s = The number of stator coils
- N_{ph} = The number of phases

Single phase generator power: The power of the generator being generated can be calculated through the following equation:

$$S_{1\phi} = V_{L-N} \times I \quad (7)$$

Where:

- $S_{1\phi}$ = The generator power (VA)
- V_{L-N} = The generator voltage (V)
- I = Represents the current (Ampere)

Design results: From Eq. 7, we get the result that this generator is designed to work at a frequency of 50 Hz and rotates at a speed of 500 Ratio per minute. The output voltage is designed 49.1 V in no-load conditions. By using aluminum-coated acrylic rotor with a diameter of 30 cm², the rotor is designed to produce 12 poles with Neodymium magnets and then the rotor is formed, so that, permanent magnet can be inserted. The number of coils is 10 pieces. This value is obtained from the large number of

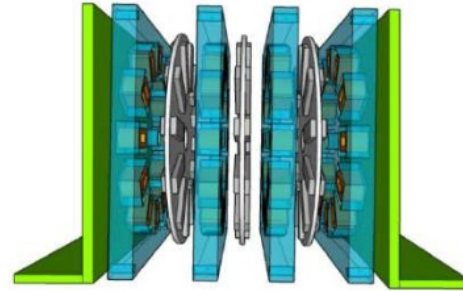

Fig. 1: Front view of 4 stator neodymium permanent magnet generators which are blue, 4 gray rotors and brown for spalls

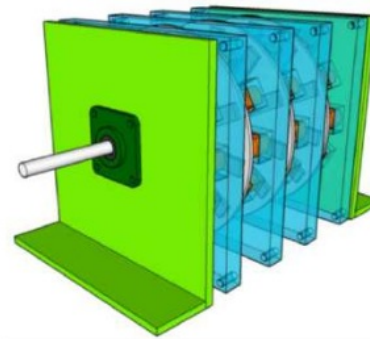

Fig. 2: Side view of neodymium 4 stator 4 rotor permanent magnet generator using white shaft and green generator housing

magnets in the rotor, so that, the stator circumference adjusts the rotor circumference. Another consideration is that the coil can be completely surpassed by magnetic flux. While the number of stator coils (N_s) needed for the stator uses with the number 2 (Phase and Neutral) and p uses 12 poles, as shown in Fig. 1-3. The number of stator coils is N_s used 12 coils using Eq. 8:

$$N_s = p \times \frac{N_{ph}}{2} \quad (8)$$

To determine the distance between the magnet and the circumference of the rotor the design aims to determine the number of magnets in accordance with its poles, the distance between the magnet and the radius of the rotor and its location on the rotor plate 80 cm² is presented in Fig. 4, that is the geometry of the permanent magnetic rotor. With a total of 12 coils with 336 turns presented in Fig. 1 and 3. This value is obtained from the large number of magnets in the rotor, so that, the

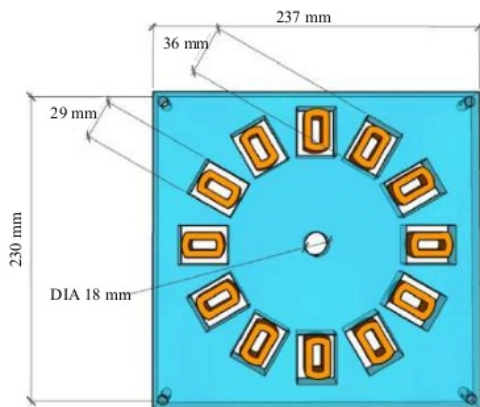

Fig. 3: Geometry of the stator coil

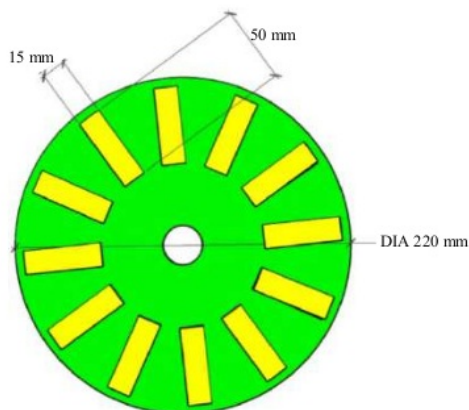

Fig. 4: Geometry of permanent magnetic rotors

circumference of the stator adjusts around the rotor. Another consideration is that the coil can be completely surpassed by magnetic flux.

RESULTS AND DISCUSSION

One phase axial flux permanent magnet generator testing is carried out to determine the planning results. If done with a good measuring instrument or with a high degree of accuracy the test results will be more accurate. No-load testing is carried out for 3 h for capturing data on current, current and rpm. The test was conducted on campus 2 of the ITN Malang electro lab building, 1st floor, Electric Energy Conversion Laboratory. The experimental results are presented in Table 1.

The measurement results of Generators 1, 2, 3 and 4 without load can be seen from 0-700 Rpm with the voltage obtained an average of 16.60 V on the stator 1, 15.03 V on Generators 2, 12.72 V on the stator 3 and

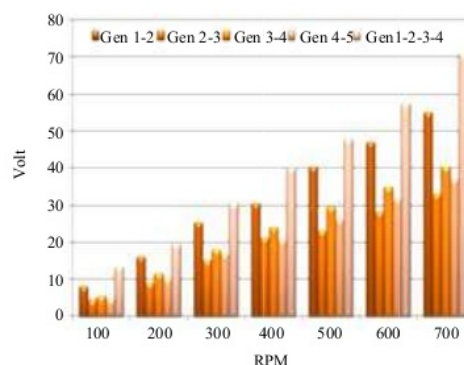

Fig. 5: Graph of no-load experiments with a series connection between. Generators 1, 2, 3 and 4 towards RPM

Table 1: No-load trial

RPM	Stator Voltage (V)				Frequency
	Generator 1	Generator 2	Generator 3	Generator 4	
100	3.80	3.50	3.00	3.40	10.30
200	8.00	7.30	5.27	6.60	20.70
300	12.60	11.20	10.20	9.80	31.40
400	16.70	15.03	13.18	13.00	42.10
500	21.10	18.88	16.40	16.20	51.70
600	24.70	22.73	19.12	19.40	61.00
700	29.30	26.58	21.90	22.60	70.90
Average	16.60	15.03	12.72	13.00	41.16

13 V on stator 4 with a frequency of 41.16 Hz per RPM. At a speed of 500 RPM the voltage generated at Generator 1 is 21.10 V with a frequency of 51.70 Hz. The speed of 500 RPM voltage generated on Generator 2 is 18.88 V with a frequency of 51.70 Hz. Speed of 500 RPM voltage generated on the generator stator 3 is 12.72 V with a frequency of 51.70 Hz. The speed of 500 RPM voltage generated by generator 4 is 16.20 V with frequency of 51.70 Hz, in the no-load experiment above the average voltage generated by the four Generators is 14.34 V per RPM with an average frequency produced by 41.16 Hz per RPM.

The measurement results of Generators 1, 2, 3 and 4 are presented in Table 2 and Fig. 5. Where the no-load experiment with a series relationship can be seen from 0-700 Rpm with the voltage obtained an average of 31.96 V on the Generator 1 and 2, 19,34 V on Generators 2 and 3, 21,30 V on Generators 4 and 1, 40,13 V on generators 1,2,3 and 4. While at speeds of 500 RPM the voltage generated on multi rotor generators and multi stator is 48.1 V with a frequency of 51.70 Hz.

Load testing: In the load test, 3 incandescent lamps with 40 W of each incandescent power capacity are used. At the time of testing, the data is taken from the multi rotor and stator generator voltage output and is presented in Table 3.

Table 2: No-load trial in series connection

RPM	Series stator Voltage (V)				
	Generator 1-2	Generator 2-3	Generator 3-4	Generator 4-1	Multi rotor and sator generator
100	8.30	4.60	5.60	5.1	13.50
200	16.30	9.30	11.80	10.4	19.80
300	25.50	15.20	18.10	17.1	30.50
400	30.70	21.30	24.10	21	40.20
500	40.60	23.30	29.50	26.5	48.10
600	47.10	28.50	35.20	31.8	57.60
700	55.20	33.20	40.40	37.2	71.20
Average	31.96	19.34	23.53	21.30	40.13

Table 3: Voltage ratio with and without load 40 W

RPM	40 W load series connection; Multi-rotor and sator generator voltage			
	No load	Loaded	Drop voltage	Current
100	13.5	9.8	3.7	-
200	19.8	18.7	1.1	0.02
300	30.5	27.6	2.9	0.02
400	40.2	36.5	3.7	0.04
500	48.1	45.4	2.7	0.06
600	57.6	54.3	3.3	0.06
700	71.2	63.2	8	0.07
Average	40.1	36.5	3.6	0.00

Table 4: No load and load voltage comparison (80 W)

RPM	80 W load series connection; Multi-rotor and sator generator voltage			
	No load	No load	No load	No load
100	13.5	9.30	4.20	-
200	19.8	18.10	1.70	0.02
300	30.5	23.10	7.40	0.06
400	40.2	29.50	10.70	0.11
500	48.1	43.30	4.80	0.14
600	57.6	48.10	9.50	0.15
700	71.2	58.90	12.30	0.16
Average	40.1	33.47	6.66	0.11

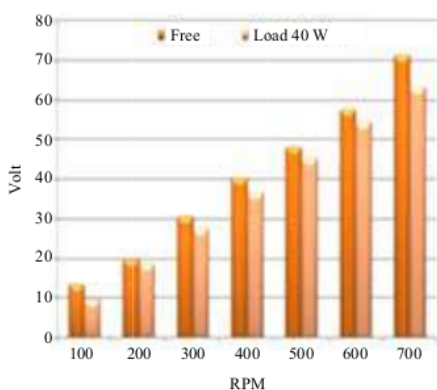

Fig. 6: Graph of comparison of no-load voltage and load with 40 W load

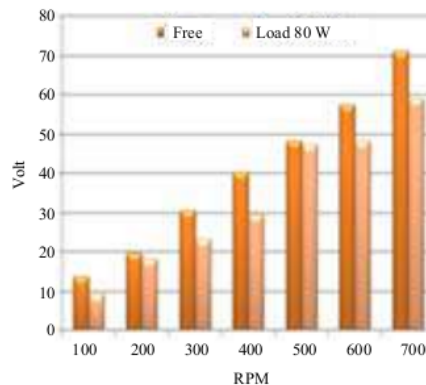

Fig. 7: Graph of comparison of no-load voltage and load with 80 W load

The measurement results of the multi rotor generator and the stator with a load of 40 W can be seen from 0-700 Rpm with a comparison of the load voltage and no-load voltage obtained on average at no load of 40.1 V and at the time of loading of 36.5 V, so that, it can be seen an average voltage drop of 3.6 V per RPM (Fig. 6). Whereas in the speed of 500 RPM the no-load voltage generated is 48.1 V and has a load of 45.2 V because it can be seen that the voltage drop generated is 2.7 V. With Amperes produced at 0.06 Amperes.

The measurement results of the multi rotor generator and stator with a load of 80 W can be seen from 0-700 Rpm in Table 4 and Fig. 7. With a comparison of the load voltage and no load, the voltage obtained is an

average of 40.1 V at no load and when burdened by 43.3 V, so that, it can be seen an average drop voltage of 6.66 V Per RPM. Meanwhile, in the speed of 500 RPM the no-load voltage generated is 48.1 V and has a load of 47.3 V because of that, we can see the voltage drop produced by 4.8 V. With the current generated is 0.14 Amperes.

Measurement results of multi rotor and stator generators with a load of 120 W can be seen from 0-700 Rpm presented in Table 5 and Fig. 8 with a comparison of the load voltage and no-load voltage obtained on average at no load of 40.13 V and when the load is 30.03 V, we can see an average voltage drop of 10.1 V per RPM. Meanwhile, in the speed of 500 RPM the no-load voltage generated is 48.1 V and is loaded with

Table 5: Comparison of no-load and no-load voltages load (120 W)
120 W load series connection; Multi-rotor and stator generator voltage

RPM	No load	No load	No load	No load
100	13.50	12.50	1	-
200	19.80	14.80	5	0.090
300	30.50	18.90	11.6	0.120
400	40.20	28.60	11.6	0.180
500	48.10	41.50	6.6	0.210
600	57.60	42.10	15.5	0.210
700	71.20	51.80	19.4	0.240
Average	40.13	30.03	10.1	0.175

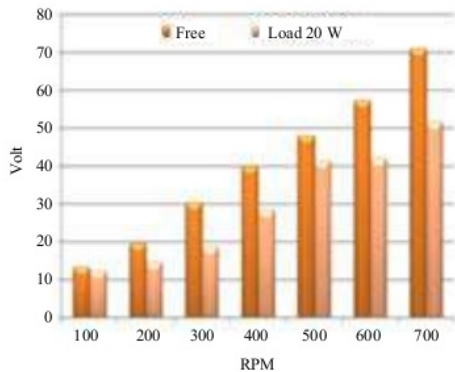

Fig. 8: Graph of comparison of no-load voltage and load with a load of 120 W

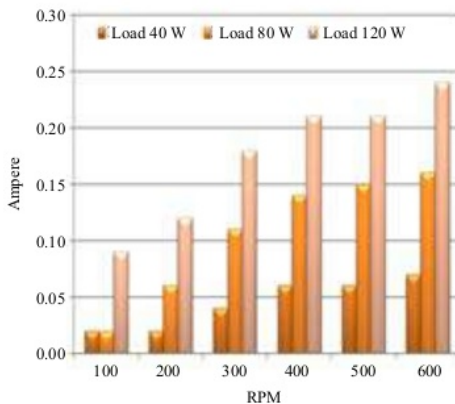

Fig. 9: Comparison graph of multi rotor and stator generator currents

41.5 V because of that, we can see the voltage drop produced by 6.66 V with the current generated by 0.21 Amperes.

The results of measurement of currents from multi rotor and stator generators with a load of 40, 80 and 120 W from 0-700 Rpm presented in Fig. 9. With the ratio

of load currents obtained on average at 40 W loads of 0.0 Ampere and at a load of 80 W at 0.1 Ampere and at a load of 120 W at 0.2 Ampere. 14 Amperes and at a load of 120 W of 0.21 Amperes.

CONCLUSION

From the research done, it can be seen that the neodymium 4 stator 4 rotor permanent magnet axial flux generator as a substitute for generators on the market is the latest breakthrough as an initial energy generator. With a generator rotation of 500 Rpm at nominal rotation and a frequency of 50 Hz in the plan that is made to produce 49.7 V of pure AC, at voltage measurements with a speed of 500 RPM get the voltage on generator 1 is 21.10 V, Genertor 2 is 18, 88 V, Generator 3 is 12.72 V and Generator 4 is 16.20 V with a Frequency of 51.70 Hz, while in a no-load measurement the multi-stator and multi-rotor generators produce an output voltage of 48.1 V with a frequency of 51, 70 Hz and the measurement is loaded with a speed of 500 RPM multi-stator and multi-rotor generator with a load of 40 W produced a voltage of 45.2 V with a current of 0.06 Amperes, at a load of 80 watts produces a voltage of 43.3 V with a current of 0, 14 Amperes and at a load of 120 W is produced a voltage of 41.5 V with a current of 0.21 Amperes.

REFERENCES

- Nasir, B.A., 2014. Design considerations of micro-hydro-electric power plant. *Energy Procedia*, 50: 19-29.
- Pasalli, Y.R. and A.B. Rehiara, 2014. Design planning of micro-hydro power plant in hink river. *Procedia Engin. Sci.*, 20: 55-63.
- Goudar, V., Z. Ren, P. Brochu, M. Potkonjak and Q. Pei, 2013. Optimizing the output of a human-powered energy harvesting system with miniaturization and integrated control. *IEEE. Sen. J.*, 14: 2084-2091.
- Khaledian, A. and M.A. Golkar, 2017. Analysis of droop control method in an autonomous microgrid. *J. Applied Res. Technol.*, 15: 371-377.
- Michael, P.A. and C.P. Jawahar, 2017. Design of 15 kW micro hydro power plant for rural electrification at valara. *Energy Procedia*, 117: 163-171.
- Zappala, D., N. Sarma, S. Djurovic, C.J. Crabtree, Mohammad and P.J. Tavner, 2019. Electrical & mechanical diagnostic indicators of wind turbine induction generator rotor faults. *Renewable Energy*, 131: 14-24.

07. Cetin, E. and F. Daldaban, 2017. Analyzing distinctive rotor poles of the axial flux PM motors by using 3D-FEA in view of the magnetic equivalent circuit. *Eng. Sci. Technol. Int. J.*, 20: 1421-1429.
08. Minaz, M.R. and M. Celebi, 2017. Design and analysis of a new axial flux coreless PMSG with three rotors and double stators. *Results Phys.*, 7: 183-188.
09. Shufat, S.A., E. Kurt, C. Cinar, F. Aksoy, A. Hancerliogullari and H. Solmaz, 2019. Exploration of a stirling engine and generator combination for air and helium media. *Applied Therm. Eng.*, 150: 738-749.
10. Arnold, D.P., 2007. Review of microscale magnetic power generation. *IEEE. Trans. Magn.*, 43: 3940-3951.
11. Jaber, H., M. Khaled, T. Lemenand and M. Ramadan, 2019. Effect of generator load on hybrid heat recovery system. *Case Stud. Therm. Eng.*, Vol. 13, 10.1016/j.csite.2018.11.010
12. Niroomand, M. and H.R. Foroughi, 2016. A rotary electromagnetic microgenerator for energy harvesting from human motions. *J. Applied Res. Technol.*, 14: 259-267.
13. Singh, A.N., W. Doorsamy and W. Cronje, 2018. Thermographical analysis of turbo-generator rotor. *Electr. Power Syst. Res.*, 163: 252-260.
14. Signe, E.B.K., O. Hamandjoda and J. Nganhou, 2017. Methodology of feasibility studies of micro-hydro power plants in Cameroon: Case of the micro-hydro of Kemken. *Energy Procedia*, 119: 17-28.

Cover Letter

¹ Eko Yohanes Setyawan
Mechanical Engineering, National Institute of Technology Malang
Jl. Bendungan Sigura-gura No.2 Malang 65152, Indonesia.

December 02, 2020

Dear Editor International Journal of Mechanical and Mechatronics Engineering,
I wish to submit a new manuscript entitled “ **Design and Performance Analysis of Double Axial Flux Permanent Magnet Generator**” for consideration by the Editor International Journal of Mechanical and Mechatronics Engineering. I confirm that this work is original and has not been published elsewhere nor is it currently under consideration for publication elsewhere.
Please address all correspondence concerning this manuscript to me at:
parulian.nommensen@gmail.com
Thank you for your consideration of this manuscript.

Sincerely,
Signed
Eko Yohanes Setyawan

IJENS COPYRIGHT FORM

This form is intended for original work submitted to the *International Journal of Engineering n Sciences* and must accompany any such work in order to be published by the IJENS Publisher. Fill in the required information, submit it together with your full paper and must email the copyright form to editor@ijens.org or editor.ijens@gmail.com.

IJENS

E-mail: editor@ijens.org or editor.ijens@gmail.com Web Site: <http://www.ijens.org>

Journal: IJET IJVIPNs IJBAS IJCEE IJMME IJECS

Volume: 19 _____ **Issue Number:** 07 _____

List of Authors / Contributors: Eko Yohanes Setyawan, Choirul Soleh, Awan Uji Krismanto, Richard A. M Napitupulu, Parulian Siagian

Title of Contribution : Design and Performance Analysis of Double Axial Flux Permanent Magnet Generator

Address: Departemen Mechanical Engineering, Faculty of Technology Industry, ¹ National Institute of Technology Malang, Jl. Sigura-gura No. 2 Malang

City Malang **Province/State** East Java **Country/Zip Code** Indonesia / 65145

E-mail:
parulian.nommensen@gmail.com

It is herein agreed that:

The copyright to the contribution identified above is transferred to IJENS. The copyright transfer covers the exclusive right to reproduce and distribute the contribution, including reprints, translations, photographic reproductions, microform, electronic form, or any other reproductions of similar nature.

The *International Journals of Engineering n Sciences* only publishes articles of the highest quality. When authors decide to submit an article to any of these journals for possible publication, their submissions indicate that the work described in their paper should not have been previously published, or be under consideration for publication elsewhere, in the same or similar form.

The author first warrants that his/her contribution is original, except for such excerpts from copyrighted works as may be included with the permission of the copyright holder and author thereof, that it contains no libelous statements, and does not infringe on any copyright, trademark, patent, statutory right, or proprietary right of others.

Author's Signature: _____ **Date:** December, 02 2020

Design and Performance Analysis of Double Axial Flux Permanent Magnet Generator

Eko Yohanes Setyan¹, Choirul Soleh², Awan Uji Krismanto³, Richard A. M Napitupulu⁴, Parulian Siagian^{5*}.

¹ Mechanical Engineering Dept, National Institute of Technology Malang

^{2,3} Electrical Engineering Dept, National Institute of Technology Malang

Jl. Bendungan Sigura-gura No.2 Malang 65152, Indonesia.

^{4,5} Mechanical Engineering Dept, Nommensen HKBP University

Jl. Sutomo 4A Medan 20234, Indonesia.

Correspondence: parulian.nommensen@gmail.com Tel.: +62-81226670831

Abstract— In this paper, a novel permanent magnet generator structure is proposed in order to facilitate implementation of the permanent magnet generator on small scale renewable energy-based power generation. Detail characteristic of an double axial flux permanent magnet generator is analyzed. The proposed generator structure consists of two-sided rotor which equipped with slots for placing permanent magnet. The stator side is comprising of three groups of coreless winding for realizing three phase output. Performances of the axial flux double permanent magnet generator are observed involving the output voltage, currents and power. Two experimental scenarios have been tested to monitor the performance of the generator. In first scenario, loading condition which represented by star connection of three bulbs of 25 W has been considered. The rotational speed of the tested generator in this scenario is 501.9 rpm. It was monitored that under those loading circumstance, three phase sinusoidal output voltages with frequency under 50 Hz have been monitored. Moreover, above 50 Hz operational frequency, the output voltage waveform slightly changes from sinusoidal to trapezoidal shapes. In second scenarios, the proposed generator is connected to the rectifier to form a DC system. The 45 W load has been considered in this DC scenario. Under DC system test, 152.2 V output DC voltage, 0.1614 A current and 24.976 W power have been monitored when the rotational speed of axial flux double permanent magnet generator was 847.9 rpm.

Index Term— Double axial; permanent magnet; renewable energy

I. INTRODUCTION

The axial flux permanent magnet generator was invented around 150 years ago [1]. The invented generator structure has advantages such as higher power density, better cogging torque and simple construction resulting more efficient and cheaper manufacturing production [2]. Moreover, axial flux type of generator ensures low distortion and purely sinusoidal voltage output waveform [3-5]. From flux point of view, geometry structure of axial flux generator is the important features to increase power density [6]. Effects of core shape, lamination, air-gap and core losses on efficiency of Axial Flux Permanent Magnet Generator (AFPMG) with FEA have been investigated. It was found that the dimension of magnetic core should be minimized in order to improve efficiency and generator performances [7]. The increase of power output of the generator

can be achieved by increasing the number of coils. Therefore, in order to increase the output power without significantly change the generator construction, it is preferable to use double-side rotor than single-side rotor configurations [9].

Enhancement of generator performance can also be achieved by considering various configuration of the core. The core of the generator can be either slotted or slot-less which aims to reduce cogging torque and mitigate inductance losses respectively [10]. Moreover, interaction force between core and permanent magnet should be carefully considered to optimally reduce the cogging torque [11]. Magnetic force in axial flux generator potentially introduces larger mechanical pressure and vibration to the machine due to larger air gap in axial flux generator than in radial flux generator [9]. The air gap usually can be designed in between 1 mm to 4 mm with considering the mechanical process of the generator. It is important to be noted that the dimension of air gap influences the output of the generator [12]. Therefore, optimization of air gap dimension should be conducted in design process of axial flux generator [13]. In coreless type of rotor, the winding should be put into the non-magnetic material with isoelastic characteristic such as epoxy and polyamide. The coreless rotor type results in less weight of generator and the absence of core loss and cogging torque. On the other hand, the drawback of coreless type of generator is the increase of loss due to eddy current effect in the field winding under high speed operation of the generator [13]. Lower magnetic fluxes which influence the efficiency of the generator also become a concern in coreless rotor type [14]. The other factor that influence the generator characteristic is air gap. As previously mentioned, smaller air gaps would increase the output of generator. Conversely, higher air gap introduces more losses in generator [15].

In comparison with radial flux, axial flux permanent magnet generator has low cogging torque and higher power density and efficiency [16]. Higher power density in axial flux permanent magnet generator results in increase of operating temperature of the generator. Therefore, in axial flux generator, air gap design is important to reduce the operating temperature [17],[19]. In order to achieve good generator performance in axial flux permanent magnet generator, stator and rotor design should be combined properly to reduce the power loss and increase the efficiency [7,8]. Two side rotor design can be considered to

increase the power output of generator. Since the proposed design doubled the generator output power [20]. In this paper, characteristic and performance of double side axial flux permanent magnet generator are analyzed. The proposed generator considers two side rotor design with permanent magnet. Moreover, in order to maintain power quality, the output of the generator is connected to rectifier to converse AC terms output into DC terms output.

II. EXPERIMENTAL APPARATUS AND METHODS

Design procedure of double side axial flux permanent magnet generator is depicted in Figure 1.

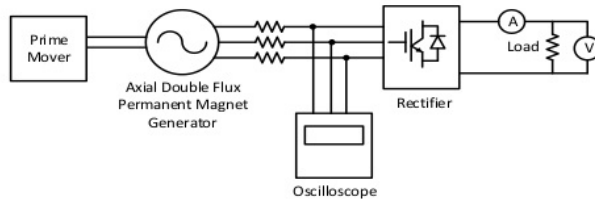

(a) Diagram of proposed double side axial flux permanent magnet generator.

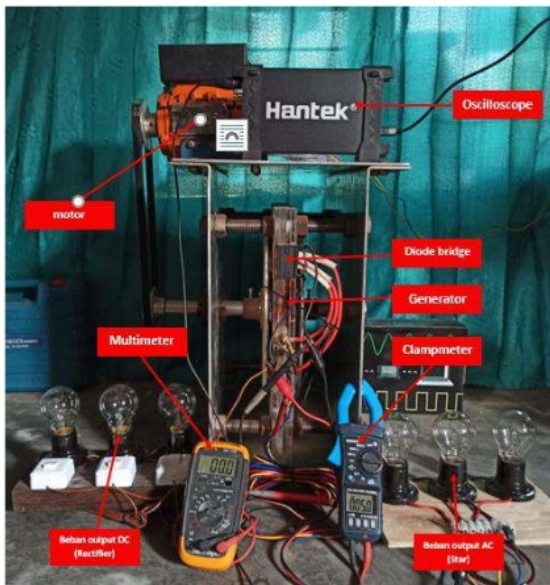

(b) experiment setup of double side axial flux permanent magnet generator.

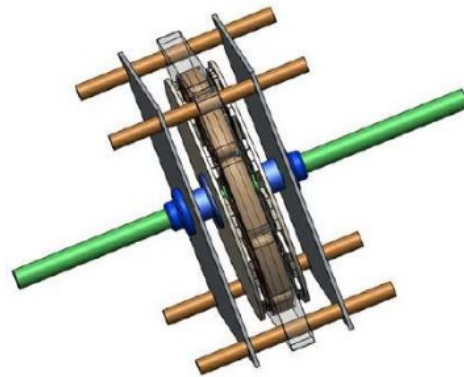

(c) the design of double side axial flux permanent magnet generator.

Figure 1. Design and experimental setup of double side axial flux permanent magnet generator.

Design of double side rotor in proposed axial flux generator is depicted in Figure 2. In this research, the dimension of generator has length of 45 cm length, width of 33 cm and height of 46 cm. The purpose of small size design of the generator is to facilitate flexibility, simple installation and portable features of the generator. The proposed rotor design incorporates double rotor type in the left and right of the stator. The rotors and stator are connected with a shaft hence it can rotate in similar speed and directions. In each side of the rotor, 12 permanent magnet of neodymium type with 50x15x6 mm dimension are installed. Hence, in the generator, there are 24 permanent magnets in the rotor side.

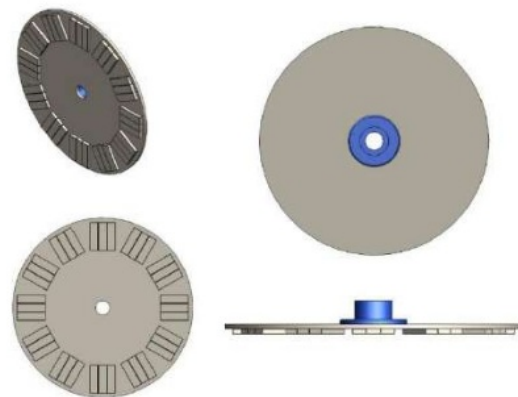

Figure 2. Design of double side rotor in proposed axial flux generator

The stator side of the proposed permanent magnet generator is the copper winding with the number of winding is nine. Since the output of the generator is three-phase, the windings are divided into three group. Each group is consisting of three winding. The conductor used in this design is copper conductor with 1 mm diameter. The number of turn in each winding is 300 turns. Moreover, the air gap between rotor and

stator is determined as 4 mm. The stator design of double side axial flux permanent magnet generator is shown in Figure.3.

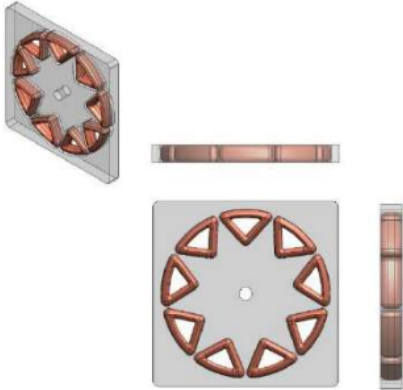

Figure 3. Stator design of double side axial flux permanent magnet generator.

The proposed design of double side axial flux permanent magnet generator has the efficient natural cooling mechanism in the surface of stator and rotor. The configuration of permanent magnet is symmetric and parallel with the position of stator winding with pole orientation of N-S-N-S. The pole orientation of rotor is complementary each other.

Theoretical Background

In three phase construction, the winding which is connected in series is further divide into three different groups. Each group represents one-phase output of the generator. It is compulsory to produce three identical output waveforms with similar phase angle to ensure a good quality of generator power output. Therefore, each group of winding should have identical shape, type of winding and number of turns. Total inductance in each phase can be stated as follows

$$L_{phase} = L_1 + L_2 + L_3 + \dots + L_n \quad (1)$$

Where L_{phase} represents a total inductance in each phase and L_1, L_2, L_3, L_n are inductance values in each winding. n is the number of winding connected in series in single phase.

Involving the terminal output voltage in each phase, load voltage and voltage drop along the winding, the voltage relationship in each phase can be represented using the following equation

$$V_{phase} - V_{Rphase} - V_{Lphase} = 0 \quad (2)$$

Where V_{phase} is phase voltage. While, V_{Rphase} and V_{Lphase} represent load voltage and voltage drop of the winding respectively.

The (2) can be written as a function of currents and impedance as follows

$$\frac{di_A}{dt} = \frac{i_A}{L_{pA}} (R_A + R_{LA}) \quad (3)$$

Where, i_A is phase current. L_{pA} is the total impedance of each phase. R_A and R_{LA} represent the load and winding resistance respectively.

Induction voltage in each phase is stated using the following equation

$$V_{LpA}(t) = -3N \frac{d\phi(t)}{dt} \quad (4)$$

Where, the coefficient of 3 represents number of group winding that are connected in similar phase and N represents number of turns in each winding.

The power output of the generator is stated as follows

$$P_{out} = 3 V(t) \cdot i(t) \quad (5)$$

Where, $V(t)$ dan $i(t)$ represent the instantaneous voltage and current respectively. The power factor is assumed as unity power factor.

In balance multi-phase system, the total output power can be determined by multiplying the single-phase output with the coefficient number which represent the number of phases. Hence, the total output power in multi-phase system is stated as follows

$$P_{out} = m \cdot V(t) \cdot i(t) \quad (6)$$

Where, m represents the number of output phase.

As previously mentioned, power losses in generator is comprising of copper losses in the winding, core loss in permanent magnet and mechanical loss [10,17]. As the main windings are located in stator, the power losses depend on the design of the stator. The total copper loss can be stated using the following equation

$$P_{cu} = m \cdot i(t)^2 \cdot R_p \quad (7)$$

In general, core loss is consisting of hysteresis, eddy current and anomalous losses. [21]. The core losse can be presented as follows

$$P_{Fe} = P_h + P_e + P_a \quad (8)$$

$$P_h = k_h \frac{f}{50} B_{pk}^{1.8} W_{Fe} \quad (9)$$

$$P_e = k_e \left(\frac{f}{50} B_{pk} \right)^2 W_{Fe} \quad (10)$$

$$P_a = k_a \left(\frac{f}{50} B_{pk} \right)^{1.5} W_{Fe} \quad (11)$$

Where P_e , P_{Fe} , P_h , and P_a represent eddy current, core, hysteresis and anomalous losses respectively. W_{Fe} is representing core mass, B_{pk} represents the peak of flux density in Tesla. While, k_a , k_e , and k_h represent coefficient constant of anomalous loss, eddy loss, and hysteresis loss respectively. According to the previous equations, the total efficiency of the generator can be stated as

$$\eta = \frac{P_{out}}{P_{out} + \Delta P} \cdot 100 \quad (12)$$

Where ΔP is the total loss of the generator.

III. RESULTS AND DISCUSSIONS

The performances of proposed axial flux double permanent magnet generator are presented. The AC side output of the generator and the DC side output after rectification process are analyzed. First experimental setup considers a loading condition with three 25 W resistive loads connected in star configuration. The waveforms of the terminal voltage at the output AC side of the generator before rectification process are monitored to assess the quality performance of the generator. Table 1 represent the monitoring results of the AC side generator terminal voltages. It was observed that the phase voltages of the generator have relatively similar magnitude values. The small difference of those magnitude values can be caused by some factors such as the shape of coil which is not perfectly identic, non-uniform air

gap distance which results in fluctuating effects of inductance values between permanent magnet and coil. Moreover, it was monitored that terminal voltage of the generator is increasing proportionally with the increase of the rotational speed. As the speed is increasing, the frequency output of the generator also increased. It was monitored that the proposed generator can be operated in utility frequency (50 Hz) with 501.9 rpm rotational speed.

Table 1. Measurement of the output voltage of each generator phase

RPM	R-N (V)	S-N (V)	T-N (V)	Frekuensi (hz)
204	17,4	16	17	20,5
305,8	25,9	23,7	25,3	30,5
417,2	32,7	29,9	32,2	41,4
501,9	39,7	36,1	38,7	50,1
612,7	48,7	44,5	47,6	60,9
718,7	56,1	51,1	54,7	70,5
807,7	63,3	57,6	61,7	80,5
894,2	71,7	65,5	70,1	90
1010,4	81,2	74,1	79,4	100,7
1141,7	89,1	81,3	87,1	110,7

Figure 4 represents the three phase AC side voltage waveform of the axial double flux permanent magnet generator. It was monitored that in 240 rpm rotational speed, the waveform of the AC side output voltage is purely sinusoidal with the operating frequency is 20.5 Hz. Moreover, the voltage magnitude of phase R is 17.4 Volt, phase S 16 Volt and phase T is 17 Volt. Figure 5 represents the three phase AC side voltage waveform of the axial double flux permanent magnet generator when it was operated in 417.2 rpm rotational speed. Similarly, it was monitored that the waveform of the AC side output voltage is purely sinusoidal with the operating frequency is 41.4 Hz. Moreover, the voltage magnitude of phase R is 32.7 Volt, phase S 29.9 Volt and phase T is 32.2 Volt. Figure 6 shows the three phase AC side voltage waveform of the axial double flux permanent magnet generator under 501.9 rpm rotational speed. In this rotational speed, operating frequency of the generator is 50.1 Hz, similar to the fundamental frequency of the utilities. Therefore, it can be observed that the proposed axial double flux permanent magnet generator can be synchronized with grid within this rotational speed. The waveform of the AC side output voltage is purely sinusoidal. Moreover, the voltage magnitude of phase R is 39.7 Volt, phase S 26.1 Volt and phase T is 38.7 Volt. As the rotational speed is continuously increased to 612.7 rpm, the operational frequency becomes 60.1 Hz. The waveform of the generator terminal voltages is changing into trapezoidal form as presented in Figure 7, with the magnitude of phase voltage is 48.7 Volt for phase R, 44.5 Volt for phase S and 47.6 Volt for phase T.

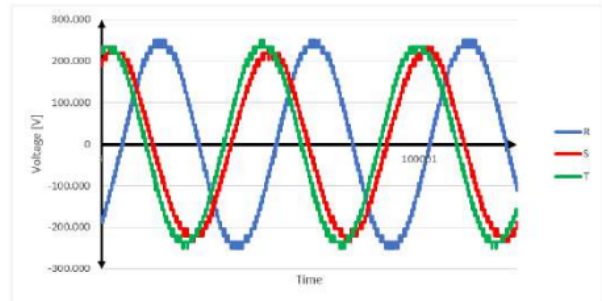

Figure 4. Three phase Voltage Output at frequency of 20,5 Hz.

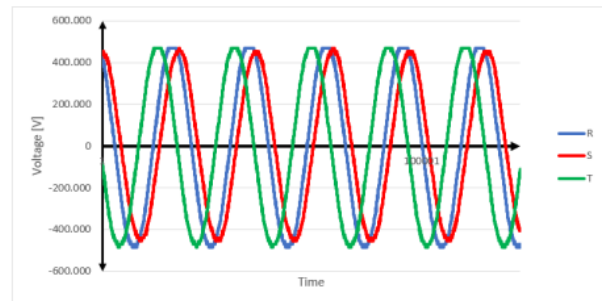

Figure 5. Three phase Voltage Output at frequency of 41.4 Hz.

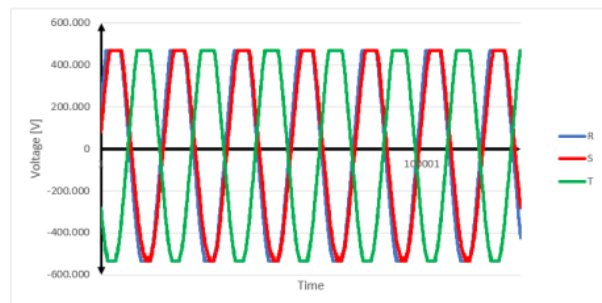

Figure 6. Three phase Voltage Output at frequency of 50.1 Hz.

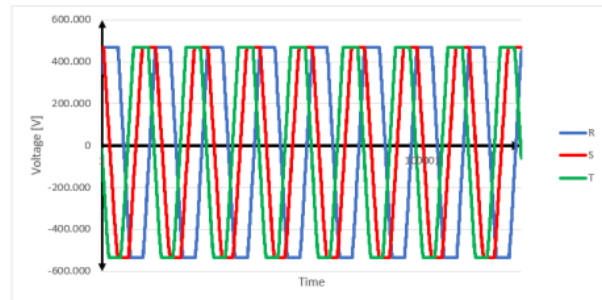

Figure 7. Three phase Voltage Output at frequency of 60.9 Hz.

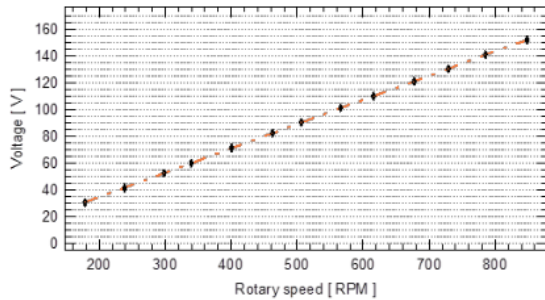

Figure 8. Correlation between rotational speed and DC voltage.

As depicted in figure 4-7, it was clearly observed that there are some concerns regarding the terminal output voltage of the generator. The phase angle among phase voltage are not equal. In ideal condition, the phase voltage should be separated by 120° each other. However, the obtained results indicated unbalanced condition of phase shift among those three phase voltages. The unbalanced in the phase voltages disturbs the current waveform significantly and deteriorating the power quality. Moreover, as rotational speed is increased, more deviation and distortion of voltage waveform are monitored, indicated by change of voltage waveform from purely sinusoidal to trapezoidal shapes. The distorted voltage and current waveform increased the harmonic content in the system. High harmonic content would result in the increase of losses and heating problems. With those concerns, it is not allowable to directly connect the AC side terminal voltage of the proposed axial flux permanent magnet generator to the load. To solve the problem, it is required to improve the power quality and reduce the distortion of AC side terminal voltages. Among several options such as connecting additional low pass filter at AC side of the generator and drastically change the construction of the generator, it is preferable to convert the distorted AC form into free-distortion DC form voltage and current. Therefore, in this paper, the AC side terminal generator is connected to full bridge rectifier to obtain the DC voltage and current.

To analyze the performance of the proposed generator and coupling full bridge rectifier, two experimental setups are considered. The first experimental setup considers a loading condition with a bulb of 45 W is considered. Figure 8 depicts the correlation between rotational speed and DC voltage. From the graph, it was observed that the DC voltage is increasing proportionally with the increase of rotational speed. Higher rotational speed results in higher DC voltage. Consequently, as the DC voltage is increasing with the increase of rotational speed, the power output the current also proportionally increasing as depicted in Figure 9. The second study case is analyzing the generator performance under load variation scenario. The connected load is increasing gradually from 15 W to 45 W with the constant rotational speed of 840 rpm. The output power is continuously increasing with the increase of connected load. At loading condition of 15 W, the output power is 8.514 W, at 25 W loading condition the measured output power is 13.520. Under 30 W and 40 W loading circumstances, the output power of the generator are 16.314 W and 22.948 W

respectively. Finally, at 45 W of load, the measured output power is 45 W. The correlation between output power as the function of load is depicted in Figure 10.

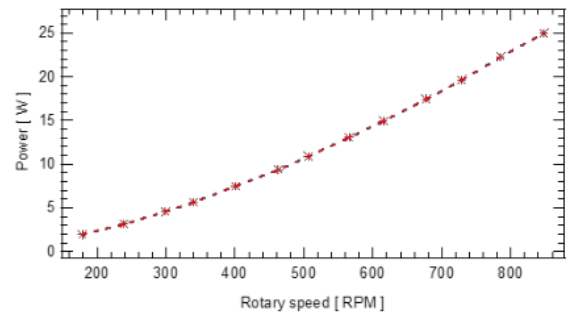

Figure 9. Correlation between output power and rotational speed.

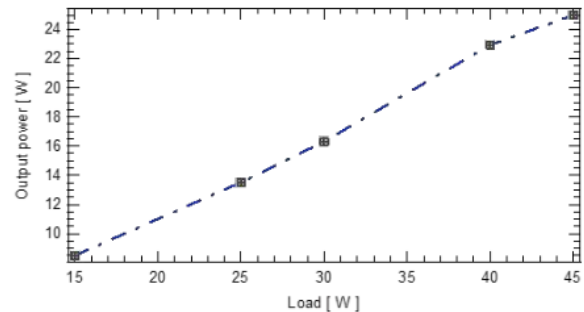

Figure 10. Correlation between output power and rotational speed.

IV. CONCLUSIONS

Design and experimental assessment of axial double flux permanent magnet generator is presented in this paper. The experimental results suggest that the AC side terminal voltage of the proposed generator has the unbalance phase shift and high distortion when it was operated in higher rotational speed. To overcome the problem, the proposed generator is connected with a full bridge rectifier to generate DC form voltage and output power. From the experimental results, it was clearly monitored that the voltage of the generator can be increased by increasing the rotational speed. Therefore, the voltage can be controlled and regulated by adjusting the rotational speed of the generator.





REFERENCES

- [1] Sadeghierad M, Lesani H, Monsef H, Darabi A. Detail modeling of high speed axial flux PMG. *Aust J Basic Appl Sci* 2009;3(2):1467-75.
- [2] Barave SP, Chowdhury BH. Optimal design of induction generators for space applications. *IEEE Trans Aerosp Electron Sys* 2009;45(3):1126-37.
- [3] Kurt E, Aslan S, Demirtas M. Cogging Torque exploration of radially and angularly directed fluxes in a new PM generator with the multiple stators. In: 7th Int. Conf. &



- Exh. ecological vehicle and renewable energies – EVER'12, Monaco; 2012. P. 1-8.
- [4] Gor H, Kurt E. Comparison of cogging torques in two different axial flux permanent magnet generators. In: EWRES, the European workshop & conference on renewable energy systems; 2013 [Antalya, Turkey].
- [5] Kurt E, Gor H. Electromagnetic design of a new axial flux generator. In: IEEE proc. electronics, computer and artificial intelligence (ECAI 2014), 6th international conference: 39-42; 23-25 oct 2014 [Bucharest, Romania].
- [6] Vansompel H, Sergeant P, Dupre L, Bossche AV. Axial-flux PM machines with variable air gap. *Ind Electron IEEE Trans* 2014;61(2):730-7.
- [7] Garrison FP, Todd DB, Comanescu M, Muller BA. Design and testing of a permanent magnet axial flux wind power generator. In: 2008 IAJC-IJME international conference, Nashville; 2008. p. 190-202.
- [8] Patterson D, Spee R. The design and development of an axial flux permanent magnet brushless DC motor for wheel drive in a solar powered vehicle. In: IEEE industrial applications society conf., Denver; 1994. 1,188-195.
- [9] So-Young S, Jae-Hoon J, Yu-Seop P. Improved analytical modeling of axial flux machine with a double-sided permanent magnet rotor and slotless stator based on an analytical method. *Magn IEEE Trans* 2012;48(11):2945-8.
- [10] Chalmers BJ, Wu W, Spooner E. An axial-flux permanent-magnet generator for a gearless wind energy system. *IEEE Trans Energy Convers* 1999;14(2):251-7.
- [11] Aydin M, Guven MK. Design of several permanent magnet synchronous generators for high power traction applications. In: Electric machines & drives conference (IEMDC), Chicago; 2013. p. 81-7.
- [12] Sadeghierad M, Lesani H, Monsef H, Darabi A. Design considerations of high speed axial flux permanent magnet generator with coreless stator. In: Power engineering conference, IPEC; 2007. p. 1097-102. Singapore.
- [13] Duy NT, King-Jet T, Shao Z, Hoan Thong N. A novel axial flux permanent-magnet machine for flywheel energy storage system: design and analysis. *IEEE Trans Ind Elect* 2011;58(9):3784-94.
- [14] Wang RJ, Kamper MJ. Calculation of eddy current loss in axial field permanent magnet machine with coreless stator. *IEEE Trans EC* 2004;19(3):532-8.
- [15] Yichen C, Pillay P, Khan A. PM wind generator comparison of different topologies. *Ind Appl Conf 39th IAS Annu Meet* 2004;3:1405-12.
- [16] Al-Aawar N, Hijazi TM, Arkadan AA. Design optimization of axial-flux permanent magnet generator. In: Electromagnetic field computation (CEFC), 14th biennial IEEE conference, Chicago; 2010. p. 1.
- [17] Bumby JR, Martin R. Axial-flux permanent-magnet air-cored generator for small-scale wind turbines. *Proc IEEE-Electr Power Appl* 2006;152(5):63-73.
- [18] Kurt E, Gor H, Demirtas M. Theoretical and experimental analyses of a single phase permanent magnet generator (PMG) with multiple cores having axial and radial directed fluxes. *Energy Convers Manag* 2014; 77:163-72.
- [19] Chan CC. Axial-field electrical machines-design and applications. *IEEE Trans Energy Convers* 1987;2(2):294-300.
- [20] Chan TF, Weimin W, Lai LL. Magnetic field in a transverse and axial-flux permanent magnet synchronous generator from 3-D FEA. *Magn IEEE Trans* 2012;48(2):1055-8.
- [21] Chan TF, Lai LL, Shuming X. Field computation for an axial flux permanent-magnet synchronous generator. *Energy Convers IEEE Trans* 2009;24(1):1-11. <http://dx.doi.org/10.1109/TEC.2008.2011830>.

 Compose

 **Inbox** 104

-  Starred
-  Snoozed
-  Sent
-  **Drafts** 12
-  More

Meet

-  New meeting
-  My meetings

Hangouts

-  Setyawan ▾ +



No recent chats



[FUEE] Submission Acknowledgement  Inbox x



Prof. Ninoslav D. Stojadinović <fueaeed@junis.ni.ac.rs>
to me ▾

Eko Yohanes Setyawan:

Thank you for submitting the manuscript, "Preliminary Study on the Prototype of 3 Phase Permanent Magnet Double Flux Axial Generator for Pico-hydropower" to Facta Universitatis, Series: Electronics and Energetics. With the online journal management system that we are using, you will be able to track its progress through the editorial process by logging in to the journal web site:

Manuscript URL:

<http://casopisi.junis.ni.ac.rs/index.php/FUElectEnergy/author/submission/7173>

Username: eko

If you have any questions, please contact me. Thank you for considering this journal as a venue for your work.

Prof. Ninoslav D. Stojadinović
Facta Universitatis, Series: Electronics and Energetics

Electronics and Energetics
<http://casopisi.junis.ni.ac.rs/index.php/FUElectEnergy>



Home > User > Author > **Active Submissions**

Active Submissions

[ACTIVE](#) [ARCHIVE](#)

ID	MM-DD SUBMIT	SEC	AUTHORS	TITLE	STATUS
7173	12-02	ART	Setyawan	PRELIMINARY STUDY ON THE PROTOTYPE OF 3 PHASE PERMANENT...	Awaiting assignment

1 - 1 of 1 Items

Start a New Submission

[CLICK HERE](#) to go to step one of the five-step submission process.

Rebacks

[ALL](#) [NEW](#) [PUBLISHED](#) [IGNORED](#)

DATE ADDED	HITS	URL	ARTICLE	TITLE	STATUS	ACTION
---------------	------	-----	---------	-------	--------	--------

There are currently no rebacks.

[Publish](#) [Ignore](#) [Delete](#) [Select All](#)

ISSN: 0353-3670 (Print)

ISSN: 2217-5997 (Online)

COBISS.SR-ID 12826626

Cover Letter

Eko Yohanes Setyawan
Mechanical Engineering, National Institute of Technology Malang
Jl. Bendungan Sigura-gura No.2 Malang 65152, Indonesia.

December 02, 2020

Dear Editor of Electronics and Energetics,
I wish to submit a new manuscript entitled “ **Preliminary Study on the Prototype of 3 Phase Permanent Magnet Double Flux Axial Generator for Pico-hydropower**” for consideration by the Editor of Electronics and Energetics. I confirm that this work is original and has not been published elsewhere nor is it currently under consideration for publication elsewhere.
Please address all correspondence concerning this manuscript to me at: misstiyu@gmail.com
Thank you for your consideration of this manuscript.

Sincerely,
Signed
Eko Yohanes Setyawan

Preliminary Study on the Prototype of 3 Phase Permanent Magnet Double Flux Axial Generator for Pico-hydropower

Eko Yohanes Setyawan¹, Choirul Soleh², Awan Uji Krismanto³, Djoko Hari Praswanto⁴, Tutut Nani Prihatmi^{5*}

^{1,4,5} Mechanical Engineering Dept, National Institute of Technology Malang

^{2,3} Electrical Engineering Dept, National Institute of Technology Malang

Malang, Jl. Bendungan Sigura-gura No.2 Malang 65152, Indonesia.

Correspondence: misstiyu@gmail.com Tel.: +62-81336655055

Abstract

Along with the dire need for generators for small-scale hydropower applications in remote areas, simple generators that are easy to make but has great performance capabilities are required. The use of this generator can be applied directly at low rotation according to the existing river characteristics, while the result can be used for street lighting in remote areas. In its use, this double flux 3 phase axial flux permanent magnet generator was designed to have a torque and efficient natural cooling mechanism on the surface of the rotor and stator. This paper presented a prototype design of a generator with a permanent magnet 2-sided rotor. The output of this generator was a 3-phase alternating current (AC) which will then enter a 3-phase rectifier to convert the electric current to pure DC (direct current). It can be reported from the test results that this generator had satisfactory performance in accordance with the construction design made.

Keywords: *Alternative Energy, Design, Direct Current*

Introduction

The axial flux generator was first discovered 150 years ago [1]. According to Frankly, machines with permanent magnets have better power density and cogging torque values, cheaper construction, and higher moment values [2]. In addition, the output wave of each phase from the axial flux generator is a sinusoidal wave [3-5].

The geometry and topology of the flux are key points for increasing the power density of permanent magnet axial flux generators [6]. As done by Vansompe, et al. conducted research on the effect of core shape, lamination on efficiency on the Axial Flux Permanent Magnet Generator (AFPMG) using FEA. In addition, it also examines the effect of air gap and core losses with the same method in terms of efficiency. Can AFPMG design the mass and volume of the core (core) should be kept to a minimum because it affects the mass, efficiency, and compactness of the generator [7]. Double side generator produces better energy than single side generator due to the number of coils [9].

Generators can be designed using different types of cores. The core can be slotted or slot less. The core design that is widely used is the layered core. While the core with a slotted design serves to help reduce cogging torque, and the core with a slotless design serves to reduce reciprocity and inductance losses [10]. However, the magnetic force between the core and the permanent magnet must be considered optimally to reduce the cogging torque [11]. Magnetic forces cause extreme mechanical stress as well as vibrations; air gaps on the axial flux generator must be greater than air gaps in radial flux generators [9]. Air gaps can usually

be designed between 1 mm to 4 mm with respect to the mechanical processing of the generator. It should be noted that air gaps affect the output of the generator [12]. Thus, the optimization of air gaps must be done in making axial fluxes generators [13]. In a coreless generator, the windings must be inserted into non-magnetic and insulating materials such as epoxy, polyamide, and so on. Due to the absence of a core, there is no core loss and cogging torque in this type of generator, so the generator is lighter. However, in coreless type generators, there are losses resulting from the eddy current effect on the windings that occur at higher speeds [13]. In addition, the weakness of this coreless generator is that it has lower magnetic fluxes compared to generators with cores. This is the main factor that causes a decrease in the efficiency of the generator [14]. Another factor that affects the characteristics of the generator is air gaps, a low value of air gaps results in a higher power output from the generator; this is due to the higher value of the induced voltage on the coil [15].

A generator with an axial flux has a lower cogging torque and has a higher power density and efficiency when compared to a generator with radial flux [16]. In axial flux permanent magnet generators heat occurs due to higher power density. Therefore the shape of the rotor and stator is designed with a large surface to overcome the heat problem that occurs [17]. The large air gap in the axial flux permanent magnet generator also plays an important role in overcoming the heat problem that occurs [19]. There are various combinations for the design of the stator and rotor in permanent magnet axial flux generators. For example, designs with one-sided rotor and double-sided stator or vice versa [7, 8]. Two-sided designs can generate relatively double energy than single-sided designs, both stator and rotor [20].

As the purpose of this research was to determine the characteristics of the 3 phase permanent magnet double flux axial generator, the generator had 2 sides of the rotor with permanent magnets. The output of this generator was 3 phase AC (alternating current) electric current which will later enter a 3 phase rectifier to convert the electric current to pure DC (direct current).

Experimental Apparatus and Methods

This study aimed to determine the characteristics of a permanent magnet double flux axial generator with an output in the form of 3 phase AC electricity. The design of the 3 phase permanent magnet double flux axial generator was shown in Figure 1.

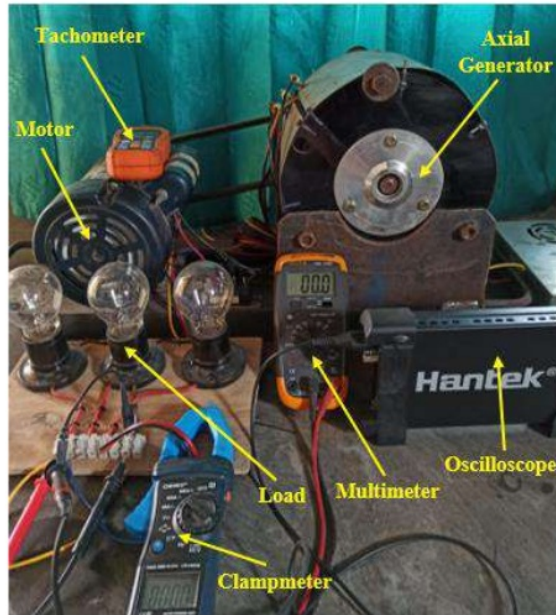
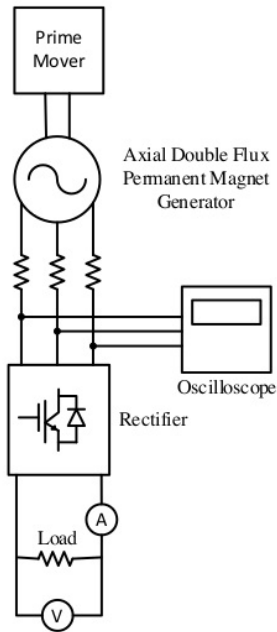

(a) Diagram and experiment setup of double side axial flux permanent magnet generator

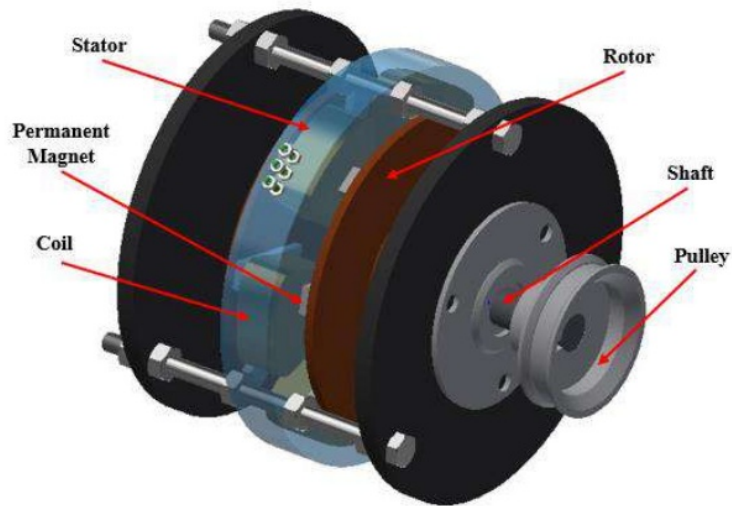

(b) design of a 3 phase double side axial flux permanent magnet generator

Figure 1. Design and experimental setup of a 3 phase double side axial flux permanent magnet generator

This generator was designed with relatively small dimensions with a stator diameter of 22 cm and a rotor diameter of 17 cm. This relatively small design aimed to make the generator more portable and easier in the installation process. This generator had double

rotors on the right and left of the stator, and the stator position was between the two rotors. The two sides of the rotor were connected through a shaft so that the two rotors rotate with the same direction and rotating speed. On one side of the rotor, there were 8 permanent magnets with the neodymium type. Therefore, this generator used 16 permanent magnets on both sides of the rotor. The design of the rotor used in the 3 phase permanent magnet double flux axial generator can be seen in Figure 2.

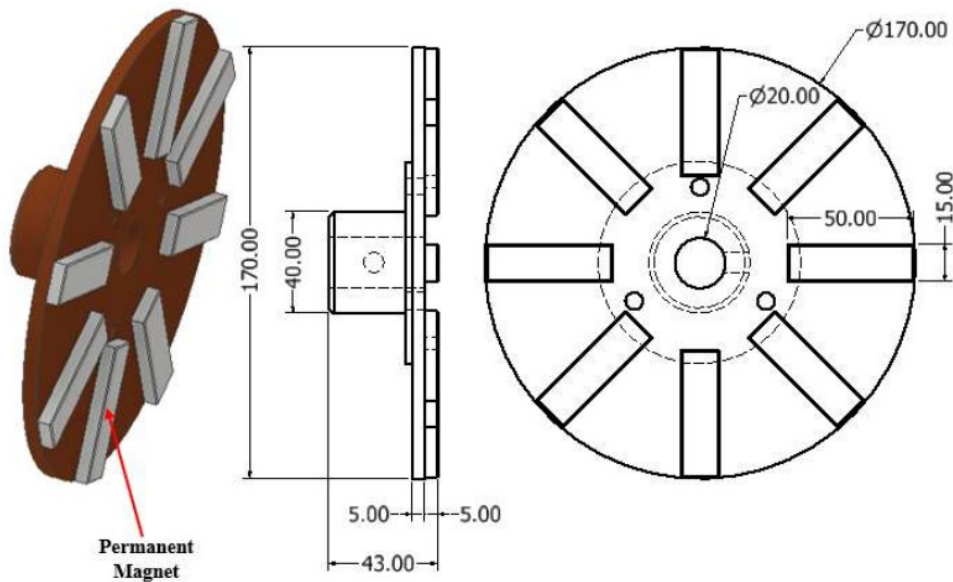

Figure 2. Design of the rotor on a 3 phase permanent magnet double flux axial generator

The stator on the 3 phase double side axial flux permanent magnet generator was a coil of copper wire with 6 coils. This generator had a 3-phase output so that 1 phase was produced from 2 coils connected to the stator. The copper wire used in this stator had a diameter of 0.8 mm. The number of turns of each coil on the stator in this 3 phase permanent magnet double flux axial generator was 400 turns. The design of the stator on the axial double flux 3 phase permanent magnet generator can be seen in Figure 3. In this generator, the air gap between the rotor and the stator was 3 mm.

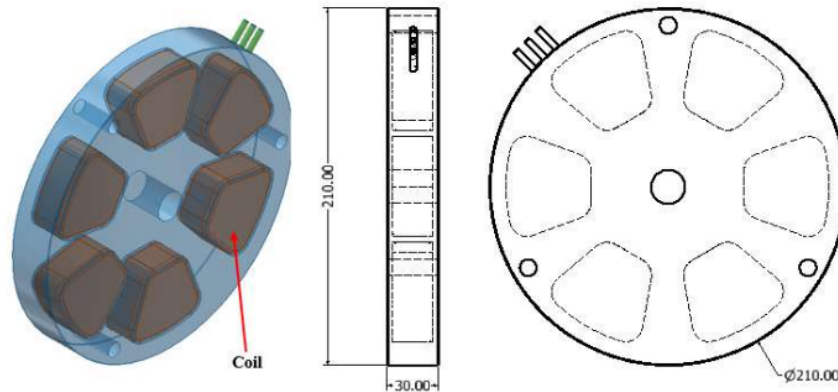

Figure 3. Design of the stator on a 3 phase double axial flux permanent magnet generator

This design featured an efficient natural cooling mechanism on the large rotor and stator surfaces. The configuration of the permanent magnet was placed symmetrically and parallel to the position of the stator coil and with the N-S-N-S pole orientation and the reverse orientation on the other side of the rotor.

Theoretical Background

In a three-phase construction, the coils connected serially were classified into three different groups. Each group of coils produced 1 phase output from the generator. It should be noted that in order to get an identical output waveform, each coil must have the same shape. The voltage for each phase was the sum of the voltages generated from each coil. In this case, the total inductance value of one phase can be written as follows:

$$L_{phase} = L_1 + L_2 + L_3 + \dots + L_n \quad (1)$$

L_{phase} was the total inductance in 1 phase, and L_1, L_2, L_3, L_n was the inductance value in each coil and n was the number of coils connected in series in one phase. By considering the voltage drop on the load and the coil, the equation for getting the value of the output voltage in one phase was as follows:

$$V_{phase} - V_{Rphase} - V_{Lphase} = 0 \quad (2)$$

Dimana V_{phase} adalah nilai tegangan pada satu phase, V_{Rphase} adalah tegangan pada beban yang terhubung pada phase, dan V_{Lphase} adalah tegangan drop pada kumparan. Jika nilai tegangan pada sebuah phase dapat ditulis sebagai berikut

V_{phase} was the value of the voltage at one phase, V_{Rphase} was the voltage at the load connected to the phase, and V_{Lphase} was the voltage drop on the coil. The voltage value in a phase can be written as follows:

$$\frac{di_A}{dt} = \frac{i_A}{L_{pA}} (R_A + R_{LA}) \quad (3)$$

In equation 3, i was the current generated in the coil in each phase. On the other hand, the induced voltage at the phase can be written as follows:

$$V_{LpA}(t) = -3N \frac{d\phi(t)}{dt} \quad (4)$$

Here the factor 3 showed the number of coils connected to 1 phase and N shows the number of turns in one coil, thus, the instantaneous power generated from 3 phases can be written as follows:

$$P_{out} = 3 V(t) \cdot i(t) \quad (5)$$

$V(t)$ and $i(t)$ were considered as one phase and the power factor is considered to be 1.

In general, the loss of power in the generator includes loss of copper wire, loss of core and loss of mechanics [10, 17]. Because the power loss was very dependent on the input and output power, the value of the power loss can be written as follows:

$$P_{out} = m \cdot V(t) \cdot i(t) \quad (6)$$

In equation 6, m showed the phase number and $V(t)$ showed the phase voltage and $i(t)$ showed the phase current at an instant. From this equation, the power loss in copper wire can be written as follows:

$$P_{cu} = m \cdot i(t)^2 \cdot R_p \quad (7)$$

Equation 7 was another form of equation 6. *Joule Heating* occurred on the coil, as can be seen from the current $i(t)$ flowing in the coil. Because the coil was located on the stator, the power loss that occurred relied on the stator design.

In general, core losses consisted of three losses, namely hysteresis, eddy, and anomalous losses [21]. Then the equation can be written as follows.:

$$P_{Fe} = P_h + P_e + P_a \quad (8)$$

$$P_h = k_h \frac{f}{50} B_{pk}^{1.8} W_{fe} \quad (9)$$

$$P_e = k_e \left(\frac{f}{50} B_{pk} \right)^2 W_{fe} \quad (10)$$

$$P_a = k_a \left(\frac{f}{50} B_{pk} \right)^{1.5} W_{fe} \quad (11)$$

Here, P_e , P_{Fe} , P_h , and P_a represented the losses caused by *eddy*, *core*, *hysteresis* and *anomalous* (in W). W_{Fe} represented the mass of the core, B_{pk} , represented the peak flux density value (in T). ΔP is the total loss in the generator. Meanwhile, k_a , k_e , and k_h are the coefficients of anomalous loss, eddy loss, and hysteresis loss. Based on the above equation, efficiency can be calculated as follows,

$$\eta = \frac{P_{out}}{P_{out} + \Delta P} \cdot 100 \quad (12)$$

Result and Discussion

Figure 4 showed a 3 phase permanent magnet dual flux axial generator. The first test was carried out by providing a load of 3 incandescent 25 watt lamps arranged in a star. This star load circuit aimed to measure the voltage and waveform at each output phase of the generator. The test results obtained were shown in Table 1.

Table 1. Measurement of the output voltage of each generator phase

RPM	R-N (Vac)	S-N (Vac)	T-N (Vac)	Frequency (hz)
312	10.6	9.7	10.6	21
420	14.4	13.4	14.8	28
515	17.4	16.3	18.2	34
614	21.1	19.7	21.9	41
713	24.4	22.6	25.2	47
825	28.4	26.5	29.3	55
900	31.1	29.1	32.1	60
1034	35.5	33.2	36.9	69
1109	38.2	35.6	39.5	74
1258	43.2	40.5	44.8	83

Table 1 showed that the output voltage of each phase of the generator resulted in a fairly small difference in voltage. The difference in voltage between the output's phases can be caused by several factors, including the shape of the coil which is less identical and the air gap in the generator that had unequal spacing. This caused the inductance between the permanent magnet and the coil to be different. The generator produced an output at a frequency of 50 Hz at a rotational speed of 755 RPM with a voltage in the R phase of 25.92 V, the S phase of 24.16 V, and the T phase of 26.9 V.

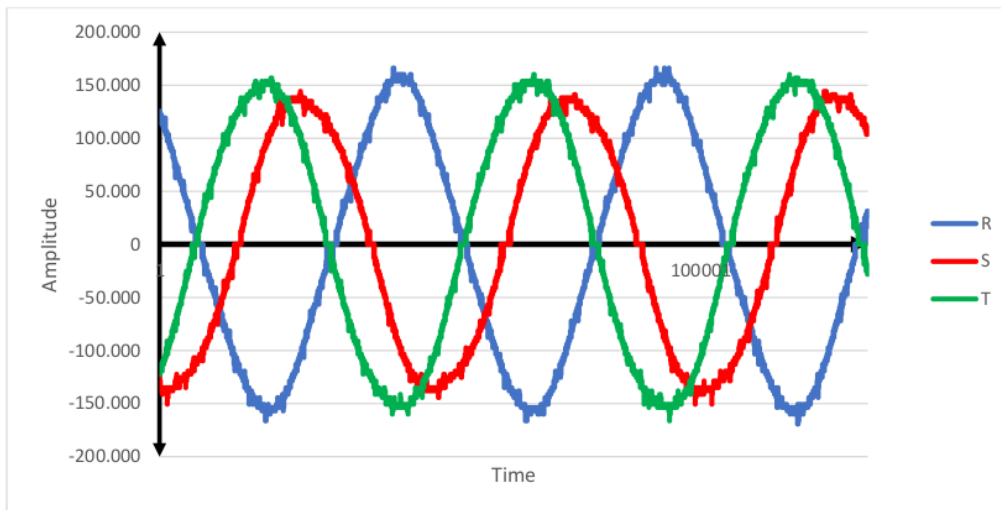

Figure 4. Three phase wave output from axial generator at 21 Hz frequency

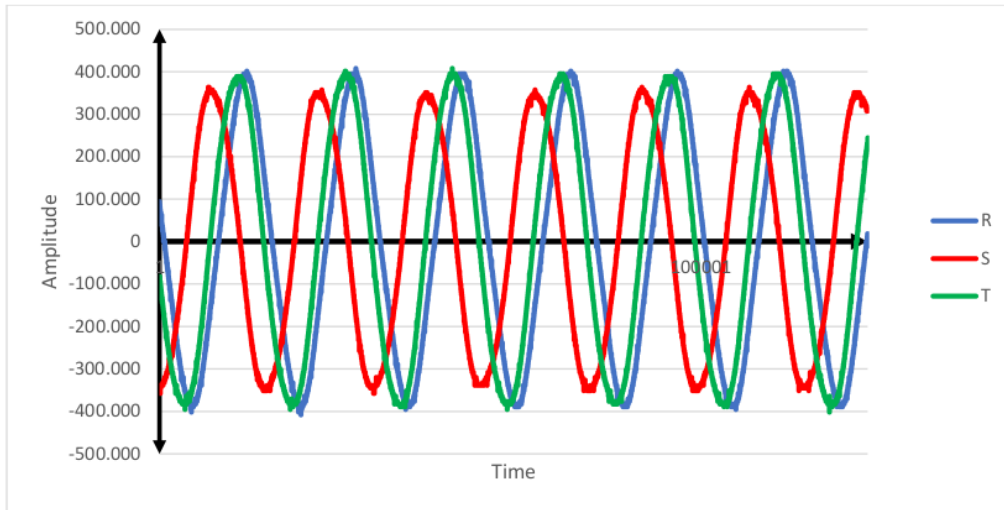

Figure 5. Three phase wave output from axial generator at 50 Hz frequency

As in Figure 4 and 5, it can be seen that there were several things to note regarding the output voltage of the generator. The phase angles between the phase voltages were not the same. In ideal conditions, the phase difference from one phase to another should be 120 degrees. However, the results obtained indicated an unbalanced shift in phase angle between the three phase voltages. The unbalanced phase voltage condition affected the current waveform significantly and reduced the power quality of the generator. In addition, as the rotational speed of the generator increased, the deviation and distortion of the voltage waveform also increased, which was indicated by the change in the voltage waveform from a pure sinusoidal to a trapezoidal waveform. Distorted voltage and current waveforms increased the harmonics in the system. High harmonic content will increase power and heat losses in the generator. Considering this condition, it was not allowed to connect the load to the AC voltage output terminal directly. To solve this problem, it was necessary to improve power quality and reduced the distortion on the terminal side of the AC voltage. There were several options included adding a low-pass-filter on the AC voltage terminal side and changed the generator construction drastically. Other better option was to convert distorted AC form to DC voltage and current that are free from distortion problems. Therefore, in this paper, the output from the generator in the form of 3-phase AC was connected to the 3-phase full-bridge rectifier to obtain DC voltage and current.

To analyze the performance of a generator with a full-bridge rectifier, two experimental scenarios were used to determine the performance of the generator. The first experiment was to load with a 75 W bulb. Figure 6 configure the correlation between the generator rotational speed and the DC output voltage. From the graph presented, it can be seen that the DC voltage increased proportionally with the increasing of rotational speed. A higher rotation speed resulted in a higher DC voltage. Consequently, when the DC voltage increased along with the increasing rotational speed of the generator, the current and output power also increased proportionally as seen in Figure 7 and Figure 8. The second experiment was to analyze the performance of the generator with a load variation scenario. The load connected to the output terminals increased gradually from 15 W to 75 W with constant rotating speed

at 800 rpm. The output power continuously increased as the connected load increased. In the load conditions of 15 W the output power was 2.54 W, while at the loading conditions of 25 W the measured output power was 2.508. In the 30 W and 45 W loading conditions, the generator output power was 3.115 W and 4.284 W, respectively. At a 45 W load, the measured output power was 9.06 W. The correlation between the output powers as a function of the load was shown in Figure 9.

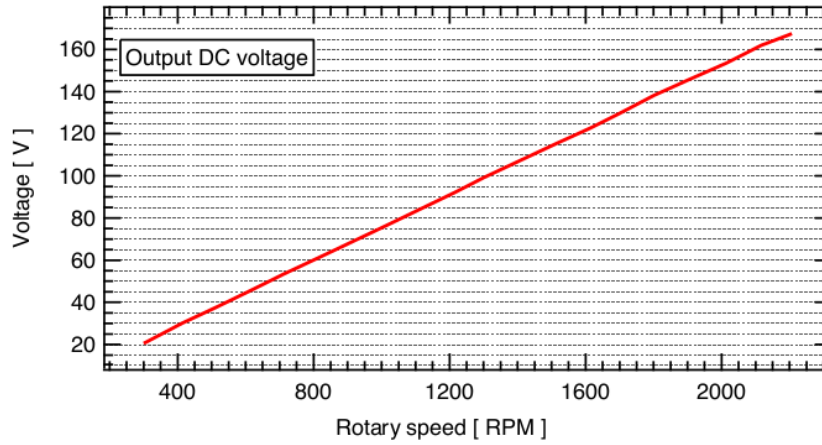

Figure 6. The relation between generator rotational speed and DC voltage output

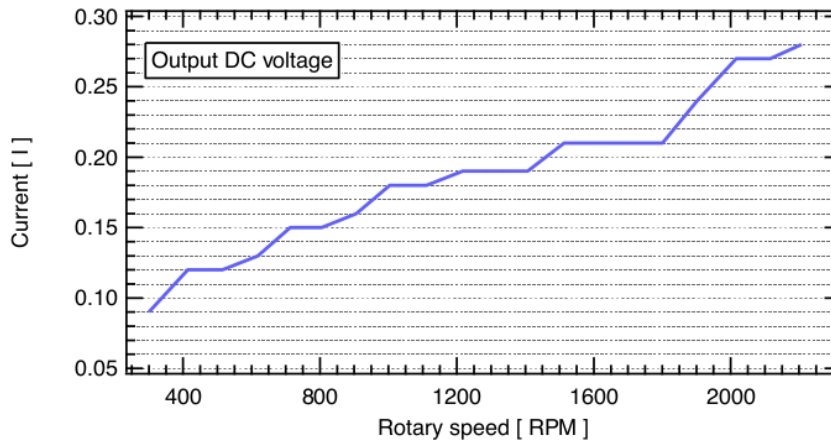

Figure 7. The relationship between generator rotational speed and DC current output

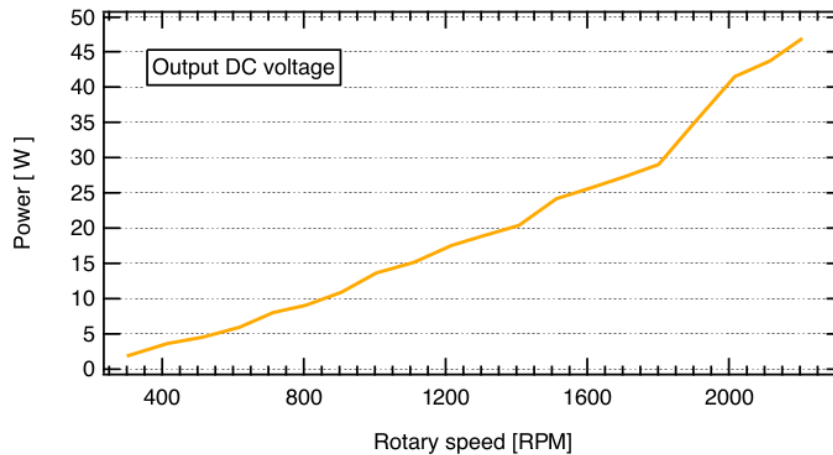

Figure 8. The relationship between generator rotational speed and power output

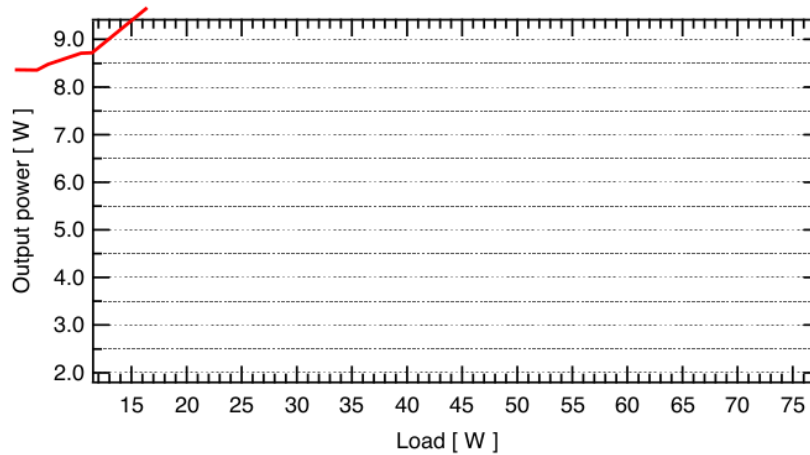

Figure 9. The relationship between load and power output

Conclusion

The testing of the 3 phase double axial flux permanent magnet generator to get the characteristics of the generator obtained that the electric wave output from the generator reached a frequency of 50 Hz at 755 RPM. At this frequency, the waves from the generator output were pure sinusoidal in the three phases of the generator output. The next test was testing the DC output of the generator. This data was measured by a 3 phase diode bridge, where the output from the generator in the form of 3 phases AC entered the rectifier in the form of a 3 phase bridge diode. The output of this rectifier produced pure DC electric current.

References

- [1] Sadeghierad M, Lesani H, Monsef H, Darabi A. Detail modeling of high speed axial flux PMG. Aust J Basic Appl Sci 2009;3(2):1467-75.

- [2] Barave SP, Chowdhury BH. Optimal design of induction generators for space applications. *IEEE Trans Aerosp Electron Sys* 2009;45(3):1126-37.
- [3] Kurt E, Aslan S, Demirtas M. Cogging Torque exploration of radially and angularly directed fluxes in a new PM generator with the multiple stators. In: 7th Int. Conf. & Exh. ecological vehicle and renewable energies – EVER'12, Monaco; 2012. P. 1-8.
- [4] Gor H, Kurt E. Comparison of cogging torques in two different axial flux permanent magnet generators. In: EWRES, the European workshop & conference on renewable energy systems; 2013 [Antalya, Turkey].
- [5] Kurt E, Gor H. Electromagnetic design of a new axial flux generator. In: IEEE proc. electronics, computer and artificial intelligence (ECAI 2014), 6th international conference: 39-42; 23-25 oct 2014 [Bucharest, Romania].
- [6] Vansompel H, Sergeant P, Dupre L, Bossche AV. Axial-flux PM machines with variable air gap. *Ind Electron IEEE Trans* 2014;61(2):730-7.
- [7] Garrison FP, Todd DB, Comanescu M, Muller BA. Design and testing of a permanent magnet axial flux wind power generator. In: 2008 IAJC-IJME international conference, Nashville; 2008. p. 190-202.
- [8] Patterson D, Spee R. The design and development of an axial flux permanent magnet brushless DC motor for wheel drive in a solar powered vehicle. In: IEEE industrial applications society conf., Denver; 1994. 1,188-195.
- [9] So-Young S, Jae-Hoon J, Yu-Seop P. Improved analytical modeling of axial flux machine with a double-sided permanent magnet rotor and slotless stator based on an analytical method. *Magn IEEE Trans* 2012;48(11):2945-8.
- [10] Chalmers BJ, Wu W, Spooner E. An axial-flux permanent-magnet generator for a gearless wind energy system. *IEEE Trans Energy Conver* 1999;14(2):251-7.
- [11] Aydin M, Guven MK. Design of several permanent magnet synchronous generators for high power traction applications. In: Electric machines & drives conference (IEMDC), Chicago; 2013. p. 81-7.
- [12] Sadeghierad M, Lesani H, Monsef H, Darabi A. Design considerations of high speed axial flux permanent magnet generator with coreless stator. In: Power engineering conference, IPEC; 2007. p. 1097-102. Singapore.
- [13] Duy NT, King-Jet T, Shao Z, Hoan Thong N. A novel axial flux permanent-magnet machine for flywheel energy storage system: design and analysis. *IEEE Trans Ind Elect* 2011;58(9):3784-94.
- [14] Wang RJ, Kamper MJ. Calculation of eddy current loss in axial field permanent magnet machine with coreless stator. *IEEE Trans EC* 2004;19(3):532-8.
- [15] Yichen C, Pillay P, Khan A. PM wind generator comparison of different topologies. *Ind Appl Conf 39th IAS Annu Meet* 2004;3:1405-12.

- [16] Al-Aawar N, Hijazi TM, Arkadan AA. Design optimization of axial-flux permanent magnet generator. In: Electromagnetic field computation (CEFC), 14th biennial IEEE conference, Chicago; 2010. p. 1.
- [17] Bumby JR, Martin R. Axial-flux permanent-magnet air-cored generator for small-scale wind turbines. *Proc IEE- Electr Power Appl* 2006;152(5):63-73.
- [18] Kurt E, Gor H, Demirtas M. Theoretical and experimental analyses of a single phase permanent magnet generator (PMG) with multiple cores having axial and radial directed fluxes. *Energy Convers Manag* 2014; 77:163-72.
- [19] Chan CC. Axial-field electrical machines-design and applications. *IEEE Trans Energy Convers* 1987;2(2):294-300.
- [20] Chan TF, Weimin W, Lai LL. Magnetic field in a transverse and axial-flux permanent magnet synchronous generator from 3-D FEA. *Magn IEEE Trans* 2012;48(2):1055-8.
- [21] Chan TF, Lai LL, Shuming X. Field computation for an axial flux permanent-magnet synchronous generator. *Energy Convers IEEE Trans* 2009;24(1):1-11. <http://dx.doi.org/10.1109/TEC.2008.2011830>.

Design and Performance of Multistage Axial Flux Permanent Magnet Generators

ORIGINALITY REPORT

8%

SIMILARITY INDEX

9%

INTERNET SOURCES

8%

PUBLICATIONS

5%

STUDENT PAPERS

PRIMARY SOURCES

1

www.e3s-conferences.org

Internet Source

3%

2

eprints.itn.ac.id

Internet Source

2%

3

Submitted to Universitas Jember

Student Paper

2%

Exclude quotes On

Exclude bibliography On

Exclude matches < 2%